

## CUPRINS

<u>ADAPTOR LIGATURI</u> .....	67
<u>APLICATOARE</u> .....	31
<u>APLICATOR FIRE</u> .....	32
<u>APLICATOR INELE DE CAUCIUC</u> .....	64
<u>APLICATOR RULOURI CURB , DREPT</u> .....	31
<u>ASPIRATOARE DE SALIVA</u> .....	84
<u>ASPIRATOARE CHIRURGICALE</u> .....	84
<u>BISTURIE</u> .....	37
<u>CHIURETE</u> .....	23
<u>CHIURETE GRACEY</u> .....	8
<u>CHIURETE ALVEOLARE DUBLE</u> .....	24
<u>CHIU VAT PENTRU TURNAT</u> .....	81
<u>CHIU VETA PENTRU MODELAT</u> .....	81
<u>CIOCAN TEHNIC</u> .....	80
<u>CIOCANEL METAL</u> .....	45
<u>CIUPITOARE OS</u> .....	61
<u>CLESTE APLICATOR INELE DE CAUCIUC</u> .....	64
<u>CLESTE CRAMPON</u> .....	68
<u>CLESTE CU TREPTE</u> .....	72
<u>CLESTE DE TURNAT CHIU VETA</u> .....	79
<u>CLESTE FOITA</u> .....	79
<u>CLESTE KOFFERDAMM</u> .....	62
<u>CLESTE LIGATURI</u> .....	67
<u>CLESTE PENTRU BUCLE</u> .....	66
<u>CLESTE PENTRU CURBURI</u> .....	72
<u>CLESTE PENTRU INDEPARTAREA CAUCIUCULUI</u> .....	72
<u>CLESTE PENTRU INDEPARTAT BRACKET</u> .....	65
<u>CLESTE PENTRU SARMA</u> .....	66
<u>CLESTE SUPORT PENTRU COROANE CERAMICE</u> .....	76
<u>CLESTI ARCIURE</u> .....	71
<u>CLESTI ARCIURE PLATE</u> .....	70
<u>CLESTI EXTRACTIE</u> .....	38
<u>CLESTI EXTRACTIE</u> .....	39
<u>CLESTI EXTRACTIE</u> .....	40
<u>CLESTI EXTRACTIE</u> .....	41
<u>CLESTI EXTRACTIE</u> .....	42
<u>CLESTI EXTRACTIE PENTRU COPII</u> .....	44
<u>CLESTI EXTRACTIE PENTRU COPII</u> .....	45
<u>CLESTI EXTRACTIE PENTRU COPII</u> .....	46
<u>CONDENSATOR OS</u> .....	56
<u>CUTIT GIPS</u> .....	77
<u>CUTIT MODELAT CEARA</u> .....	77
<u>CUTIT SEPARATOR CERAMICA</u> .....	76
<u>DALTI PLANE</u> .....	49
<u>DALTITA DE SMALT</u> .....	34
<u>DECOLATOR MUCOASA SINUSALA</u> .....	55
<u>DECOLATOR GINGIVAL</u> .....	42
<u>DEPARTATOAR VESTIBULAR</u> .....	22
<u>DEPARTATOARE</u> .....	18
<u>DEPARTATOARE</u> .....	19

<u>DEPARTATOARE</u> .....	20
<u>DEPARTATOARE</u> .....	21
<u>DEPARTATOARE DE GURA</u> .....	10
<u>DESCHIZATOR COROANE (2 CAPETE)</u> .....	51
<u>ELEVATOARE</u> .....	11
<u>ELEVATOARE</u> .....	12
<u>ELEVATOARE</u> .....	13
<u>ELEVATOR WILLIGER (RAZUSTI)</u> .....	24
<u>EXCAVATOARE</u> .....	33
<u>FIERASTRAU GHIPS</u> .....	78
<u>FOARFECA CHIRURGICALA</u> .....	15
<u>FOARFECA CUSATURA</u> .....	16
<u>FOARFECA DESCHIZATOR COROANE</u> .....	51
<u>FOARFECA GHIPS</u> .....	78
<u>FOARFECA GINGIVALA</u> .....	14
<u>FOARFECA GINGIVALA</u> .....	17
<u>FOARFECA INDEPARTAT FIRE SUTURA</u> .....	14
<u>FOARFECA PANSAMENT</u> .....	14
<u>FOARFECA PENTRU IRIS</u> .....	14
<u>FOARFECI COROANE</u> .....	82
<u>FOARFECI DE CHIRURGIE 14.5 cm</u> .....	15
<u>FULOARE</u> .....	28
<u>FULOARE</u> .....	29
<u>FULOARE</u> .....	30
<u>GRACEY CHIURETE</u> .....	8
<u>IMPLANTOLOGIE</u> .....	55
<u>INDEPARTATOR LUCRARI PROTETICE “SZTRILICH”</u> .....	50
<u>INDEPARTATOR RESTURI DE RADACINA</u> .....	47
<u>INDEPARTATOR UNIVERSAL LUCRARI PROTETICE</u> .....	50
<u>INELE DE CHIUVETA</u> .....	80
<u>INSTRUMENT GINGIVAL DE MANA</u> .....	34
<u>INSTRUMENT INDEPARTATOR LUCRARI PROTETICE</u> .....	51
<u>INSTRUMENT PENTRU MASURAT GROSIMEA COROANELOR</u> .....	54
<u>INSTRUMENT PENTRU MASURAT GROSIMEA COROANELOR</u> .....	81
<u>INSTRUMENTAR DETARTRAJ</u> .....	9
<u>INSTRUMENTE DE GRAVAT</u> .....	75
<u>INSTRUMENTE DE MODELAJ</u> .....	73
<u>INSTRUMENTE DE MODELAJ</u> .....	74
<u>INSTRUMENTE DE MODELAJ P.K. THOMAS</u> .....	75
<u>INSTRUMENTE MODELAJ COMPOZIT TITAN</u> .....	27
<u>LAMPA DE SPIRT</u> .....	53
<u>LINGURI DE AMPRENTA, METAL</u> .....	83
<u>MANER BISTURIU</u> .....	3
<u>MANERE OGLINZI</u> .....	2
<u>MENTINATOR RULOURI</u> .....	32
<u>OGLINDA NAZALA HART-MANN</u> .....	10
<u>OGLINZI DENTARE</u> .....	2
<u>PENSA ANATOMICA</u> .....	6
<u>PENSA ANATOMICA DIN TITAN</u> .....	55
<u>PENSA BRACKET</u> .....	65
<u>PENSA CHIRURGICALA</u> .....	5
<u>PENSA CHIRURGICALA</u> .....	6
<u>PENSA PENTRU CAMPURI</u> .....	3

<a href="#"><u>PENSA PENTRU DINTI DE LAPTE</u></a> .....	45
<a href="#"><u>PENSA PENTRU INSTRUMENTAR STERIL</u></a> .....	52
<a href="#"><u>PENSA PENTRU LIMBA</u></a> .....	10
<a href="#"><u>PENSE DENTARE</u></a> .....	4
<a href="#"><u>PENSE DENTARE</u></a> .....	5
<a href="#"><u>PENSE HEMOSTATICE</u></a> .....	35
<a href="#"><u>PENSE HEMOSTATICE</u></a> .....	36
<a href="#"><u>PISTOL AMALGAM</u></a> .....	32
<a href="#"><u>PLAGARE</u></a> .....	31
<a href="#"><u>PORT MATRICE TOFLEMIRE; IVORY</u></a> .....	32
<a href="#"><u>PORTACE</u></a> .....	25
<a href="#"><u>PORTACE</u></a> .....	65
<a href="#"><u>PORTLAMA BISTURIU ROTUNDA CU INCHIZATOR</u></a> .....	76
<a href="#"><u>PROTECTIE DEGETE</u></a> .....	33
<a href="#"><u>RAZUSTI</u></a> .....	24
<a href="#"><u>SONDA PARADONTALA GRADATA</u></a> .....	3
<a href="#"><u>SONDE</u></a> .....	1
<a href="#"><u>SPATULA CIMENT</u></a> .....	26
<a href="#"><u>SPATULA DE LIMBA</u></a> .....	19
<a href="#"><u>SPATULA FULOAR VAJNA</u></a> .....	31
<a href="#"><u>SUPORT FILM</u></a> .....	53
<a href="#"><u>SUPORT VATA</u></a> .....	53
<a href="#"><u>TAVITE</u></a> .....	52
<a href="#"><u>VARF MODELAJ</u></a> .....	76



**SONDE DENTARE -**  
**ZAHNSONDEN - EXPLORERS**

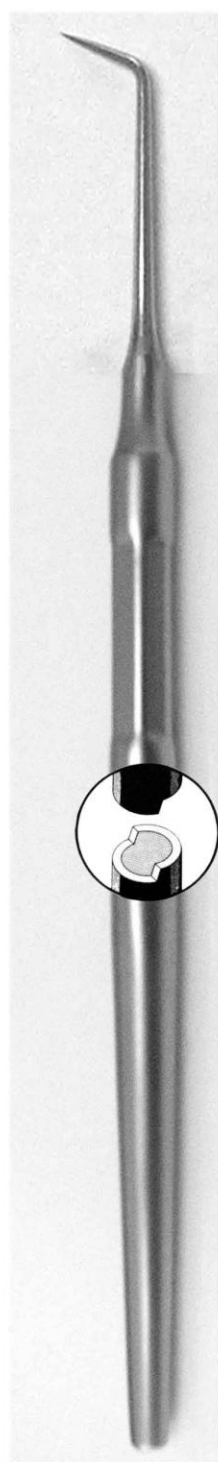

.../ HG  
4.17 €

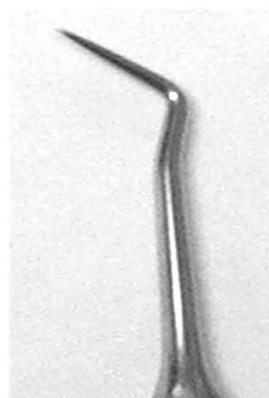

DA 1409  
2.92 €

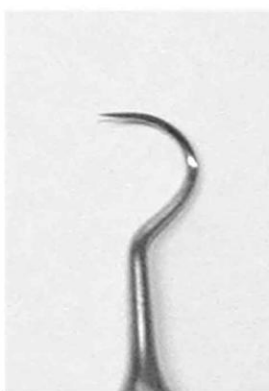

DA 1402  
2.92 €

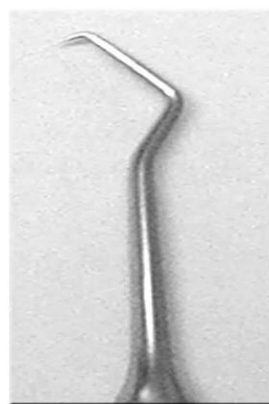

DA 1412  
2.92 €

DA 1406  
2.92 €



DA 1418  
2.92 €

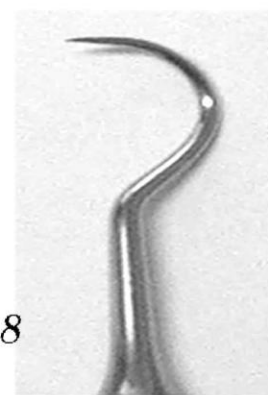

DA1414  
2.92 €

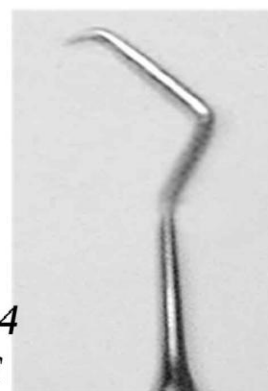

DA1408  
2.92 €

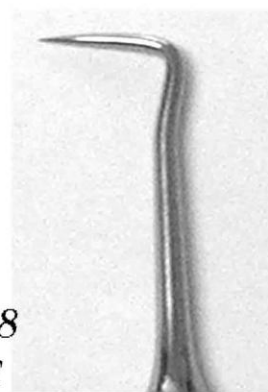

*Preturile sunt exprimate in Euro si nu includ TVA*

OGLINZI DENTARE - MUNDSPIEGEL - MOUTH MIRROR

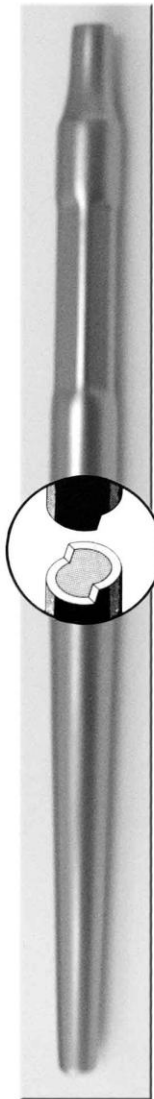

DA 181  
3.33 €



DA 180  
2.50 €



PLANA -  
PLAN -  
PLANE

DA 125  
1.67 €

24 mm



CONCAVA -  
HOHL -  
MAGNIFYING

DA 135  
2.29 €

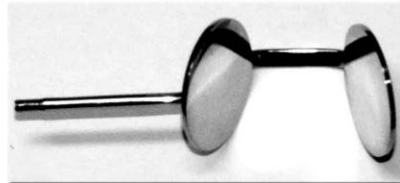

DA 136  
5.00 €

OGLINDA DUBLA - KREUTER  
DOPPELSPIEGEL METALL ROSTFREI  
DOUBLE MIRROR STAINLESS STEEL

MANER OGLINDA  
MUNDSPIEGEL GRIFF  
MIRROR HANDLE

DA 137  
4.17 €

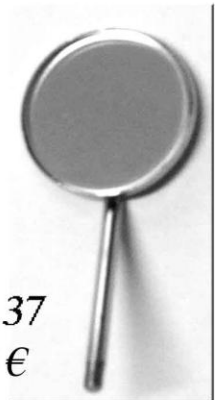

OGLINDA RODIU, PLAN  
MUNDSPIEGEL RHODIUM, PLAN  
MOUTHMIRROR RHODIUM, PLANE



DA 138  
7.50 €

OGLINDA RODIU, DUBLA  
MUNDSPIEGEL RHODIUM DOPELTE  
MOUTHMIRROR RHODIUM DOUBLE

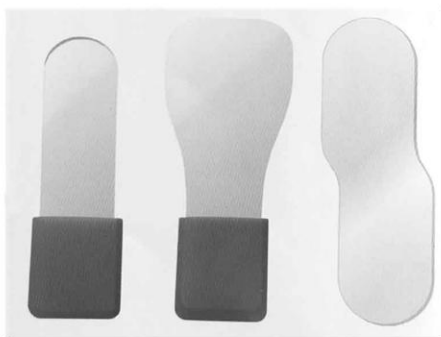

DA 140 DA 141 DA 142  
54.17 € 58.33 € 83.33 €

DA 139  
3.33 €



OGLINDA FRONTALA  
MUNDSPIEGEL FRONT  
MOUTHMIRROR, FRONT

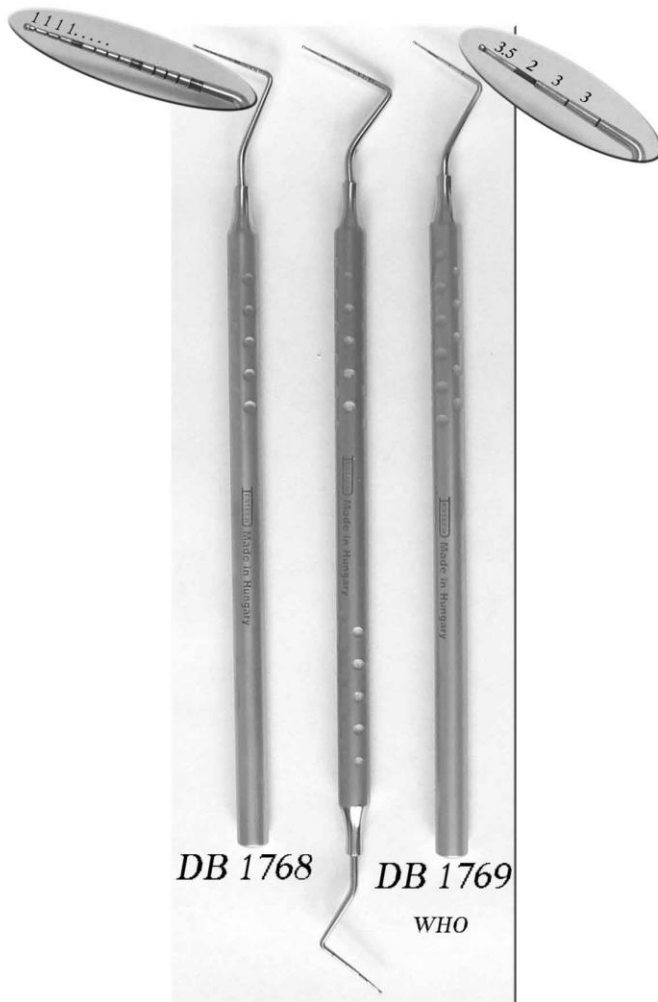

DB 1768

DB 1769

WHO

7.50€      **DB 1766**      7.50 €  
10.83 €

**SONDA PARADONTALA GRADATA**  
PARODONTOMETER  
PERIODONTOMETER

**PENSA PENTRU CAMPURI**  
TUCHKLEMME  
TOWEL CLAMPS

10.00 €

Schaedel  
8,7 cm  
**BF 1411**

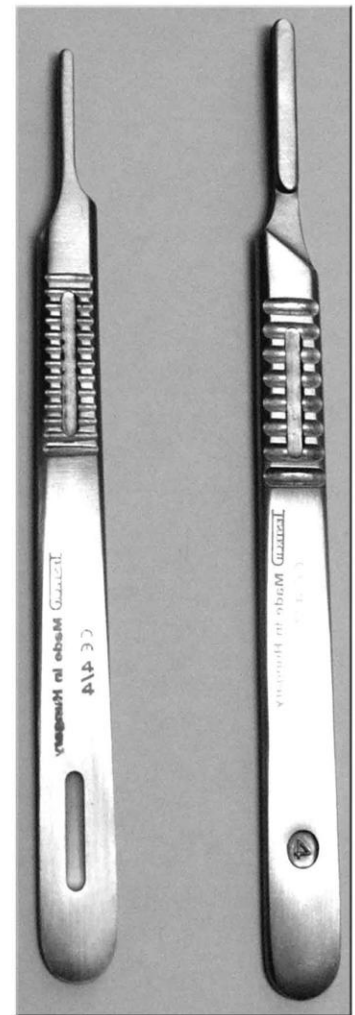

**BB 173**      **BB 184**  
5.04 €

**MANER BISTURIU**  
SKALPELL GRIFF  
SCALPEL HANDLE

**PENSA PENTRU**  
CAMPURI  
TUCHKLEMME  
TOWEL CLAMPS

11.67 €

Backhaus  
11 cm

**BF 1432**

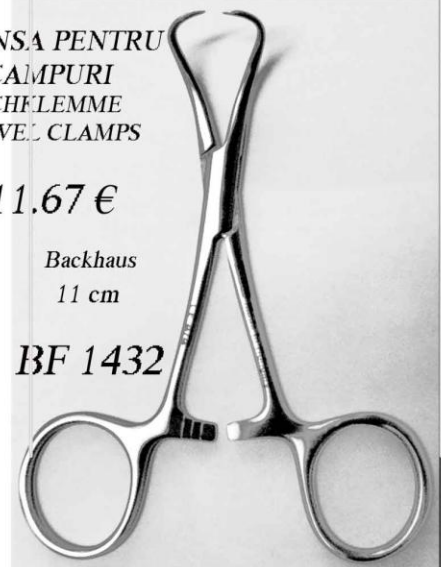

4.

PENSE DENTARE - ZAHNPINZETTEN - TWEEZERS



CU VARF  
NETED

DA 1210  
7.08 €



DA 1212  
7.08 €



CU VARF  
ZIMTAT

DA 1221  
7.50 €

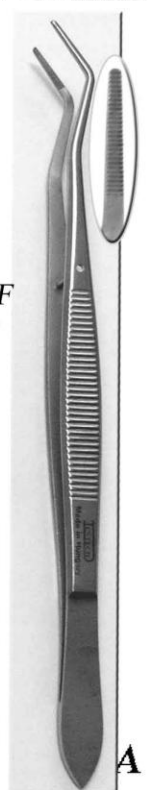

A 1225  
7.50 €

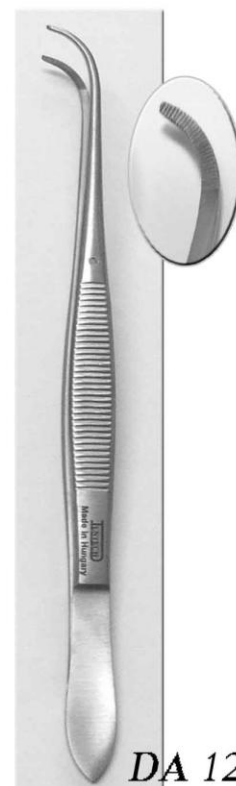

DA 1251  
7.50 €



DA 1257  
7.50 €



DA 1271  
10.83 €

CU  
INCHIZATOR

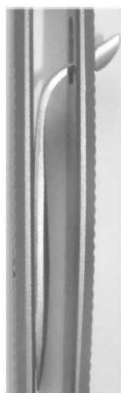

DA 1290  
7.92 €

PENSA DE RADACINA - ZAHNWURZELPINZETTEN  
PIN HOLDING TWEEZERS



DA 1291  
12.08 €

PENSA PENTRU HARTIE DE ARTICULATII  
- ARTIKULATIONSPIEPER-PINZETTEN  
FORCEPS FOR ARTICULATING PAPER



DR 1780  
10.74 €

Preturile sunt exprimate in Euro si nu includ TVA



PENSE DENTARE - ZAHNPINZETTEN - TWEEZERS



DA 2220  
7.08 €



DA 2221  
7.50 €



DA 2225  
7.50 €



DA 2251  
7.50 €

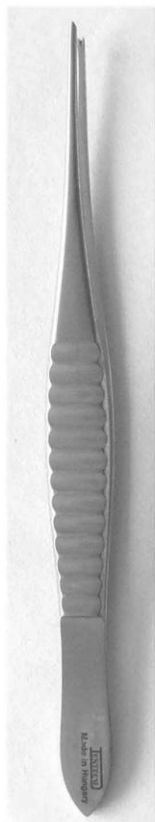

BD 1669  
8.05 €



PENSA CHIRURGICALA  
FEINE HAKENPINZETTE -  
DELICATE TISSUE FORCEPS

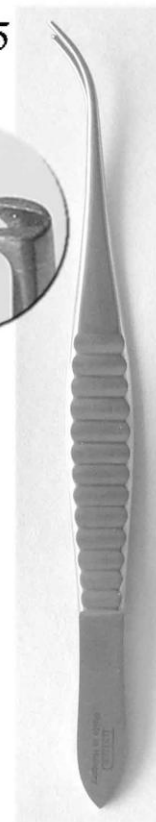

BD 1670  
8.81 €

*Preturile sunt exprimate in Euro si nu includ TVA*

6.

*PENSE ANATOMICE -*

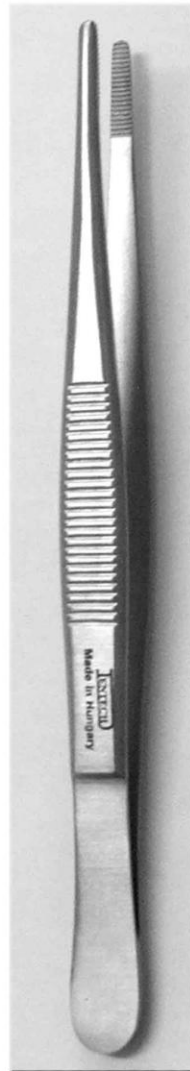

*ANATOMISCHE PITZETTE -  
DRESSING AND DISSECTING FORCEPS*

<i>BD 143</i>	<i>11.5 cm</i>	<i>5.00 €</i>
<i>BD 145</i>	<i>13 cm</i>	<i>5.42 €</i>
<i>BD 147</i>	<i>14.5 cm</i>	<i>6.25 €</i>
<i>BD 149</i>	<i>16 cm</i>	<i>7.08 €</i>
<i>BD 150</i>	<i>18 cm</i>	<i>7.50 €</i>
<i>BD 151</i>	<i>20 cm</i>	<i>8.33 €</i>
<i>BD 152</i>	<i>25 cm</i>	<i>10.00 €</i>
<i>BD 153</i>	<i>30 cm</i>	<i>11.67 €</i>



*BD 1000  
11 cm*

*PENSA PENTRU  
CORP STRAIN  
SPLITTERPINZETTE  
SPLINTER FORCEPS*

*8.05 €*

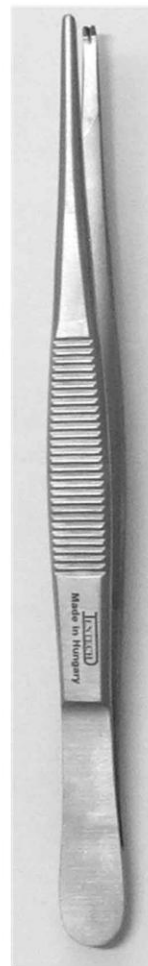

<i>BD 1553</i>	<i>11.5cm</i>	<i>5.42 €</i>
<i>BD 1555</i>	<i>13 cm</i>	<i>5.83 €</i>
<i>BD 1557</i>	<i>14.5 cm</i>	<i>6.67 €</i>
<i>BD1559</i>	<i>16 cm</i>	<i>8.05 €</i>

*PENSA CHIRURGICALA -  
HAKENPINZETTE -  
TISSUE FORCEPS*

*Preturile sunt exprimate in Euro si nu includ TVA*



**DB 1939**  
**INSTRUMENT GINGIVAL ORBAN**  
ORBÁN GINGIVECTOMY MESSER  
ORBÁN GINGIVECTOMIEMESSER

11.25 €



**DB 1938**  
**INSTRUMENT GINGIVAL KIRKLAND**  
KIRKLAND GINGIVECTOMY KNIFE  
KIRKLAND GINGIVECTOMIEMESSER

11.25 €

8.

CHIURETE GRACEY - ZAHNKÜRETEN IGRACEYI - GRACEY CURETTES

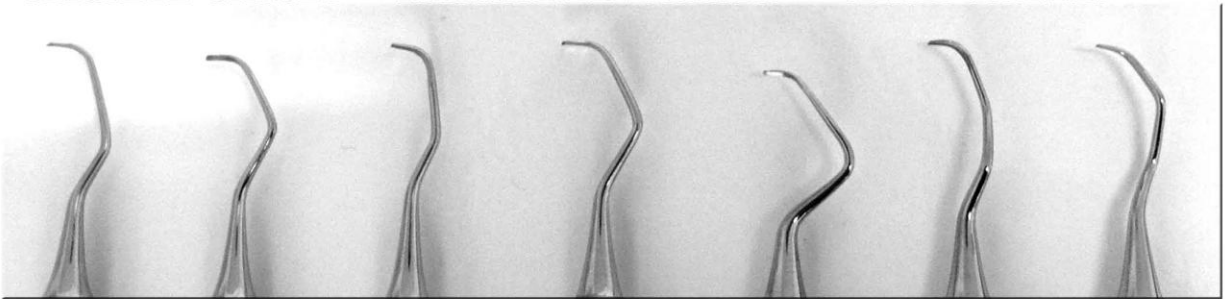

DB 1700 Fig. 1/2    DB 1701 Fig. 3/4    DB 1702 Fig. 5/6    DB 1703 Fig. 7/8    DB 1704 Fig. 9/10    DB 1705 Fig. 11/12    DB 1706 Fig. 13/14

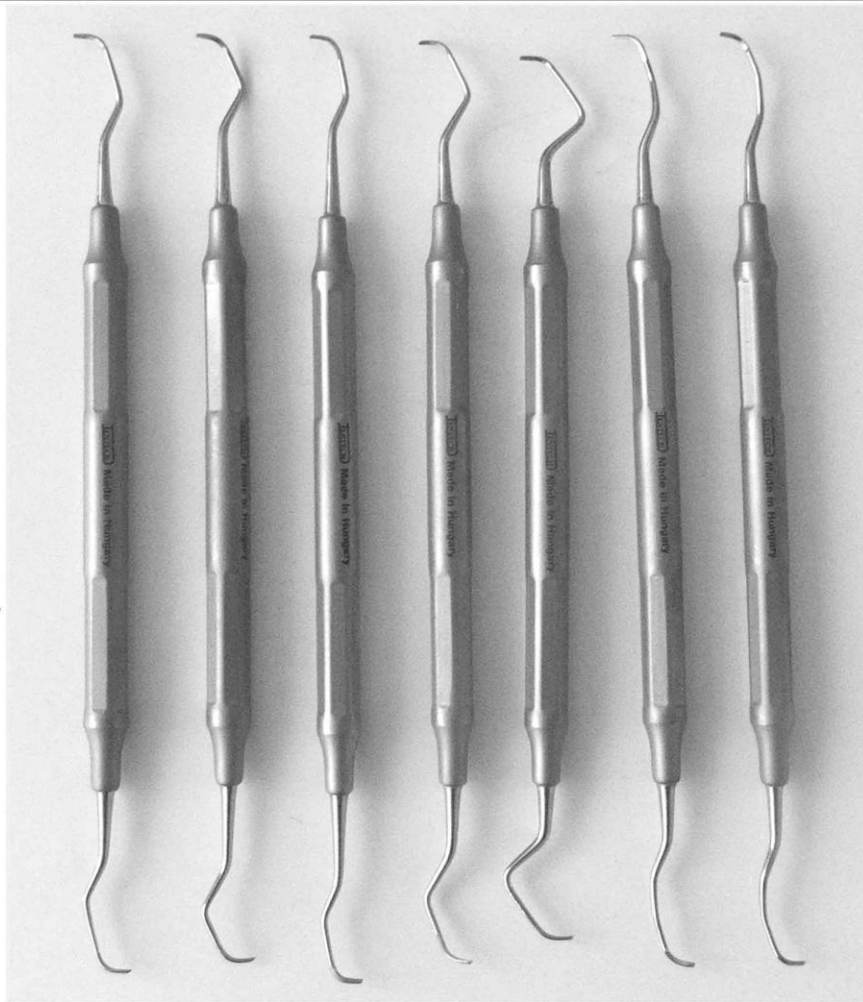
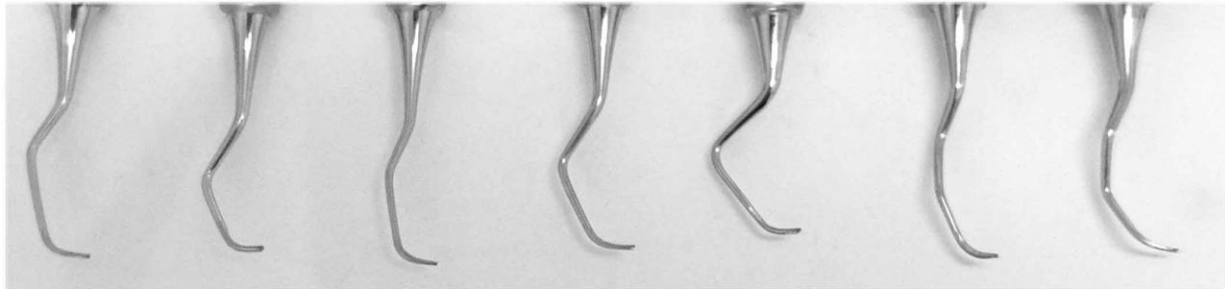

11.25 €/BUC.

*Preturile sunt exprimate in Euro si nu includ TVA*

*INSTRUMENTAR DETARTRAJ - ZAHNREINIGER - SCALERS*

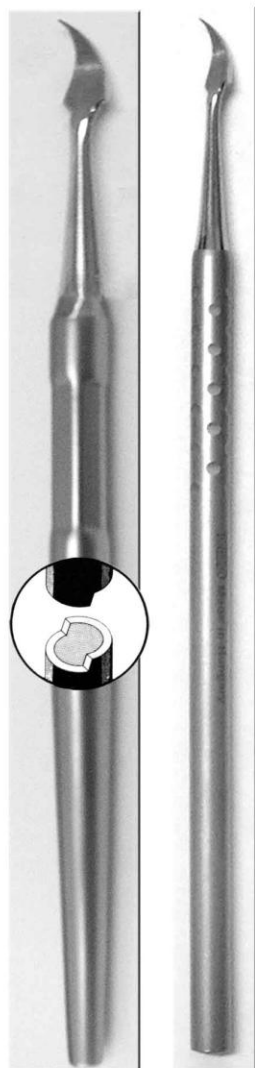

.../HG  
5.97 €

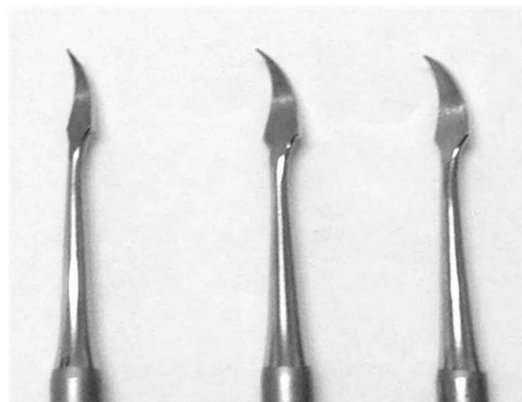

DB 1329 DB 1328 DB 1327

4.17 €



DB 1252 DB 1257 DB 1317

4.17 €

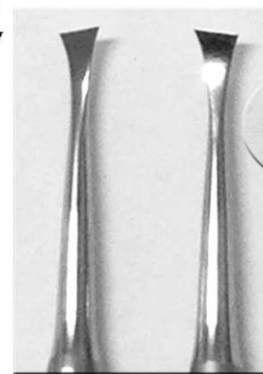

DB 1105 DB 1106

4.17 €

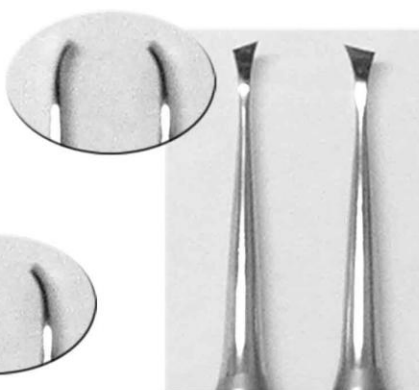

DB 1103 DB 1104

4.17 €

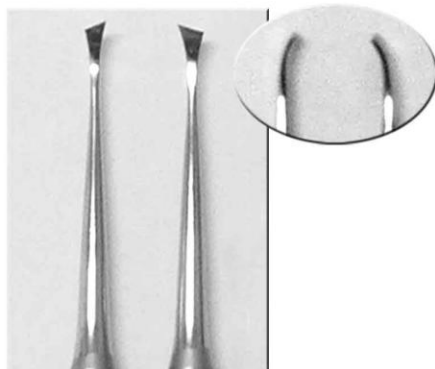

DB 1101 DB 1102

4.17 €

*Preturile sunt exprimate in Euro si nu includ TVA*

10.



**AN 1709**  
**PENSA PENTRU LIMBA**  
ZUNGEN ZANGE  
TONGUE HOLDING FORCEPS  
15 cm

22.50 €



**OR 100**  
**OGLINDA NAZALA HART-MANN**  
HART-MANN NASENSPEKULA  
HART-MANN NASAL SPECULA  
17 cm

30.75 €



**Roser - König**  
16 cm / 6 1/4 I  
**OM 149**  
38.66 €

**DEPARTOARE DE GURA**  
MUNDSPERRER  
MOUTH GAGS



**OM 130**  
**Heister**  
13 cm / 5 I  
28.00 €

*Preturile sunt exprimate in Euro si nu includ TVA*

**ELEVATOARE -**

**ZAHNWURZELHEBER -**

**ROOT ELEVATORS**

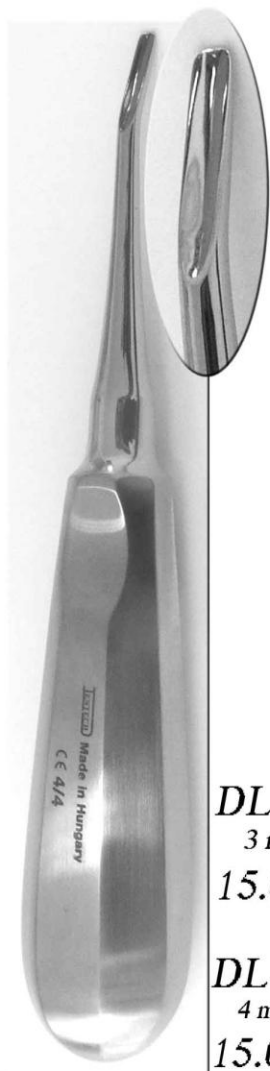

**DL 146**  
 3 mm  
 15.00 €

**DL 147**  
 4 mm  
 15.00 €

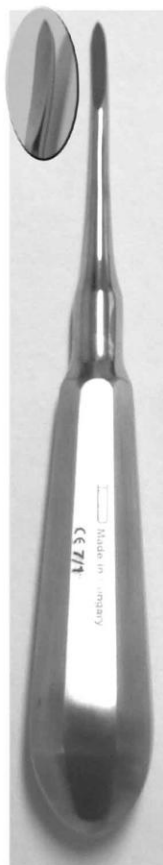

**DL 111**  
 2 mm  
 13.33 €



**DL 115**  
 3 mm  
 13.33 €



**DL 120**  
 4 mm  
 13.33 €

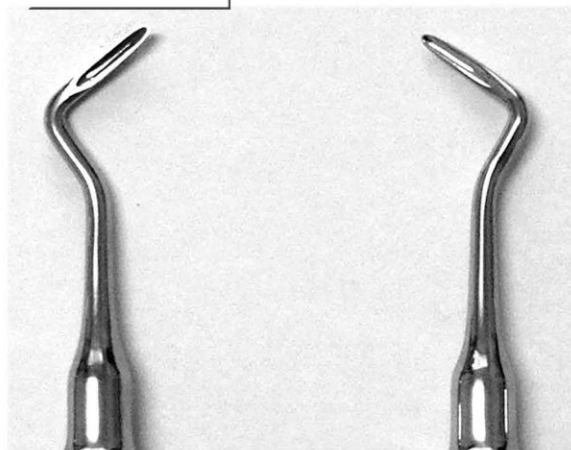

**DL 1238**  
**DL 1240**

**FLOHR**  
 3 mm  
 4 mm

**DL 1239**  
**DL 1241**

15.00 €



**DL 1236**  
**DL 1234**  
 3 mm  
 4 mm  
 14.17 €



**DL 1237**  
**DL 1235**  
 14.17 €

Preturile sunt exprimate in Euro si nu includ TVA

ELEVATOARE -

ZAHNWURZELHEBER -

ROOT ELEVATORS



**DL 132**  
2 mm  
FLOHR  
14.17 €



**DL 133**  
3 mm  
FLOHR  
14.17 €



**DL 134**  
4 mm  
FLOHR  
14.17 €



**DL 135**  
2 mm  
BEIN  
14.17 €



**DL 136**  
3 mm  
BEIN  
14.17 €



**DL 137**  
4 mm  
BEIN  
14.17 €



**DL 138**  
3 mm  
BEIN  
14.17 €

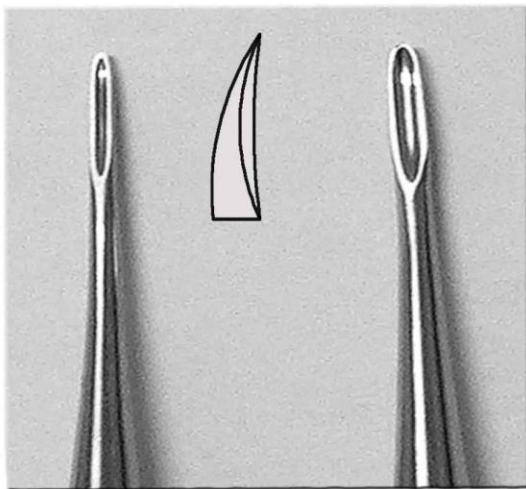

**DL 162**  
3 mm  
WHITE

15.00 €

**DL 163**  
4 mm  
WHITE

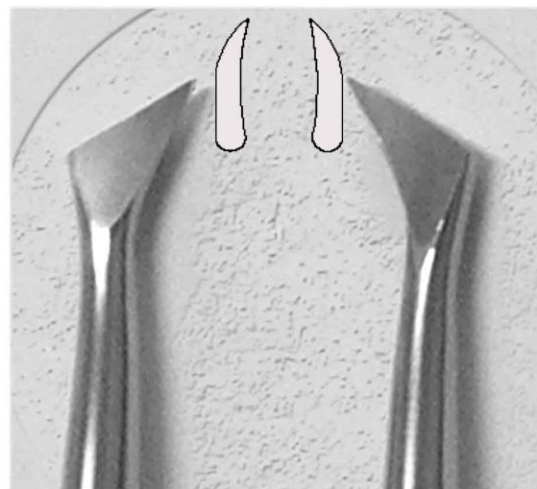

**DL 1229**

WINTER

15.83 €

**DL 1230**

*Preturile sunt exprimate in Euro si nu includ TVA*



ELEVATOARE -

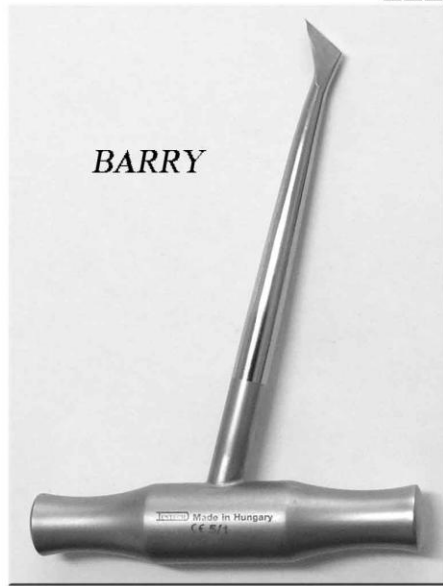

BARRY

ZAHNWURZELHEBER -

ROOT ELEVATORS

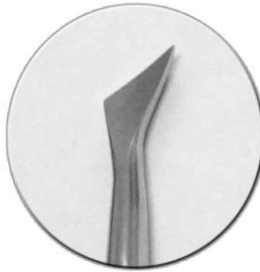

DL 1421  
15.83 €



DL 1422  
15.83 €



WINTER



DL 1427  
15.83 €



DL 1428  
15.83 €



DL 1409  
15.83 €

DL 1410  
15.83 €

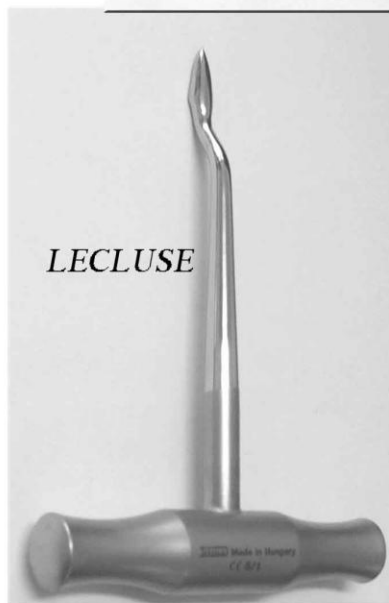

LECLUSE

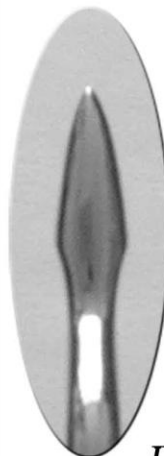

DL 1400  
15.83 €

Preturile sunt exprimate in Euro si nu includ TVA

14.

FOARFECA PENTRU IRIS - IRISSCHEREN - IRIS SCISSORS

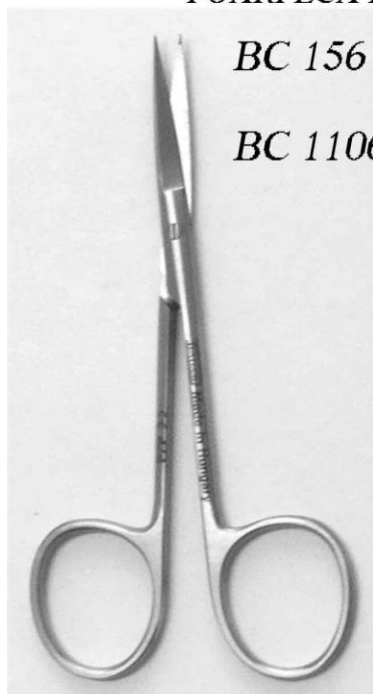

BC 156 10.5 cm 12.84 €

BC 1106 11.5 cm 13.75 €

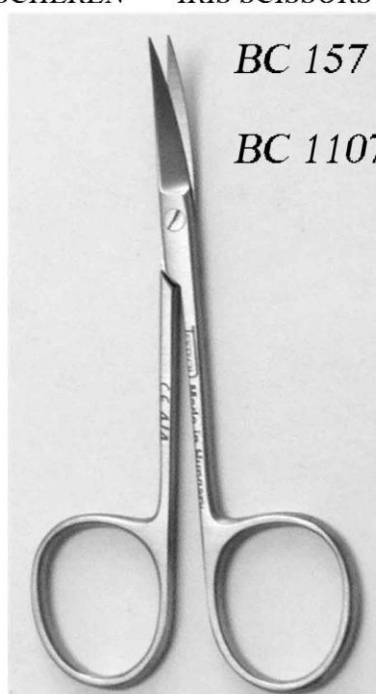

BC 157 10.5 cm 13.75 €

BC 1107 11.5 cm 14.66 €



BC 1851 14.5 cm 14.66 €

BC 1852 18 cm 16.50 €

BC 1853 20 cm 17.88 €

FOARFECA PANSAMENT  
VERBANDSCHERE  
BANDAGE SCISSORS

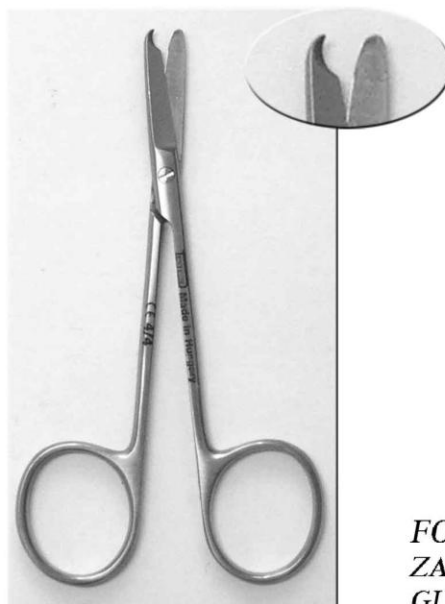

BC 1802 11 cm

BC 1803 14.5 cm

SPENCER  
FOARFECA INDEPARTAT FIRE SUTURA  
LIGATUR SCHERE  
LIGATURE SCISSORS 15.83 €

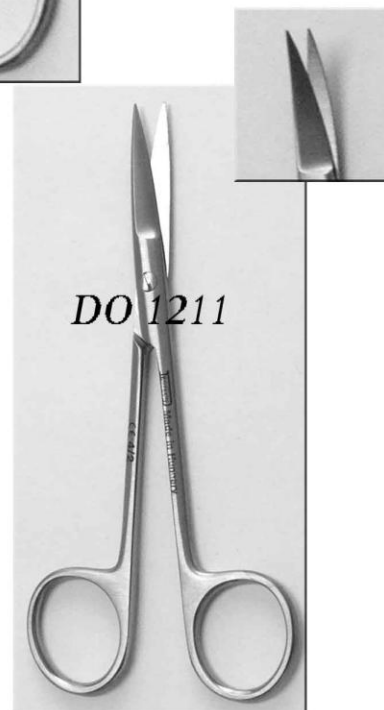

DO 1211

DO 1210  
FOARFECA GINGIVALA 12 cm  
ZAHNFLEISCHSCHERE  
GUM SCISSORS

14.66 €

Preturile sunt exprimate in Euro si nu includ TVA

**FOARFECI DE CHIRURGIE 14.5 cm -**

**CHIRURGISCHE SCHEREN 14.5 cm -**

**SURGICAL SCISSORS 14.5 cm**

**DREPTE - GERADE - STRAIGHT**



**BC 1314**  
**13.75 €**

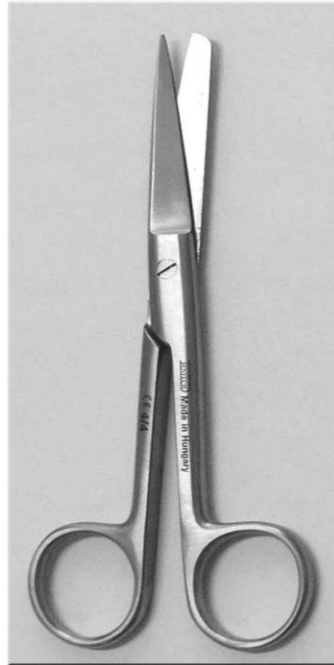

**BC 1324**  
**13.75 €**



**BC 1344**  
**13.75 €**

**HAJLÍTOTT - GEBOGEN - CURVED**



**BC 1414**  
**14.66 €**



**BC 1424**  
**14.66 €**



**BC 1444**  
**14.66 €**

*Preturile sunt exprimate in Euro si nu includ TVA*

16.



FOARFECI CHIRURGICALE  
SCHERE FÜR STOMATOLOGIE  
SCISSORS FOR STOMATOLOGY

BC 1000

17.50 €

LA GRANGE

11 cm



BC 1001

18.75 €

GOLDMANN-FOX

13 cm

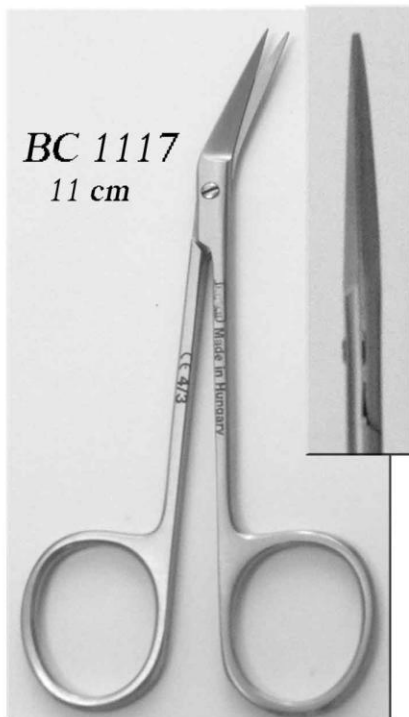

BC 1117

11 cm

FOARFECA CUSATURA

LIGATUR SCHERE

LIGATURE SCISSORS 17.50 €



BC 1156

BC 1157

JOSEPH

14 cm

16.67 €

17.50 €

Preturile sunt exprimate in Euro si nu includ TVA



**BC 1118**  
drept  
gerade  
straight

FOARFECA TIP METZENBAUM -  
METZENBAUM-FINO-SCHERE  
METZENBAUM-FINO SCISSOR  
18 CM  
19.50 €

**BC 1114**  
drept  
gerade  
straight  
16.18 €



**BC 1119**  
curbat  
gebogen  
curved  
20.52 €



**BC 1115**  
curbat  
gebogen  
curved  
17.23 €



**BC 117A**  
drept  
gerade  
straight  
18.33 €

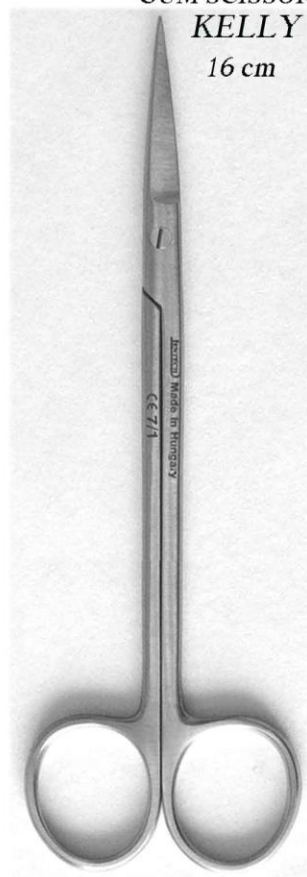

FOARFECI GINGIVALE  
ZAHNFLEISSCHEREN  
GUM SCISSORS

**KELLY**  
16 cm

**BC 1175**  
curbat  
gebogen  
curved 19.17 €



**BC 1176**  
forma S  
S förmig  
S shaped  
21.00 €

FOARFECA TIP METZENBAUM - FINO  
METZENBAUM-FINO-SCHERE  
METZENBAUM-FINO SCISSOR  
14,5 CM

18.



**BT 1400**  
18.5 cm

**DEPARTATOR TIP BALOGH**  
WUNDHAKEN NACH BALOG  
RETRACTORS BALOGH

21.08 €



**BT 1401** 19.5 cm

**DEPARTATOR**  
WUNDHAKEN  
RETRACTORS

22.00 €

*Preturile sunt exprimate in Euro si nu includ TVA*

DEPARTATOARE - MUNDHAKEN - RETRACTORS



**OM 1205**  
SPATULA DE LIMBA  
ZUNGENSPEL  
TONGUE SPATULAS  
3.96 €



**BT 1404** 15 x 15 mm 200 mm 8"  
**BT 1405** 20 x 22 mm 210 mm 8 1/2"  
**BT 1406** 26 x 30 mm 230 mm 9"  
**DEPARTATOARE FEREASTRA**  
19.71 €

DEPARTATOR CHIRURGICAL, BONT  
WUNDHAKEN, STUMPF  
RETRACTOR, BLUNT

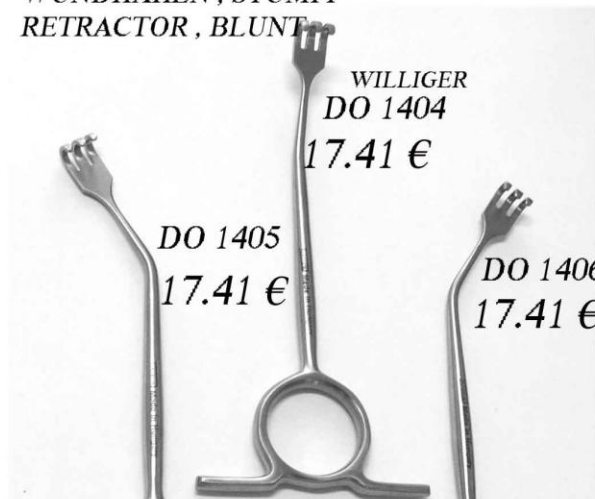

**WILLIGER**  
**DO 1404**  
17.41 €

**DO 1405**  
17.41 €

**DO 1406**  
17.41 €



CARLIG TRAHEAL/DEPARTATOR  
WUNDHAKEN  
RETRACTORS

- ASCUTIT**  
**SHARF**  
**SHARP**
- BT 1111** 9.00 €
  - BT 1112** 11.50 €
  - BT 1113** 13.50 €
  - BT 1114** 15.50 €



160 mm

- BONT**  
**STUMPF**  
**BLUNT**
- BT 1116** 9.00 €
  - BT 1117** 11.50 €
  - BT 1118** 13.50 €
  - BT 1119** 15.50 €

## DEPARTATOARE - WUNDHAKEN - RETRACTORS



BT 1354 25 x 6 mm 17.41 €



BT 1356 35 x 8 mm 17.41 €



BT 1357 35 x 11 mm 17.41 €



BT 1358 35 x 15 mm 17.41 €



BT 1359 41 x 11 mm 17.41 €



BT 1361 55 x 11 mm 17.41 €

17.41 € BT 1320 28 x 10 mm



17.41 € BT 1321 28 x 14 mm



17.41 € BT 1322 33 x 14 mm



17.41 € BT 1323 28 x 16 mm



17.41 € BT 1325 40 x 10 mm



17.41 € BT 1326 40 x 13 mm



Preturile sunt exprimate in Euro si nu includ TVA



DEPARTATOARE - WUNDHAKEN - RETRACTORS



VOLKMANN



BT 1342	38 x 10 mm	17.41 €
BT 1343	36 x 15 mm	17.41 €
BT 1344	35 x 20 mm	17.41 €
BT 1345	34 x 25 mm	17.41 €
BT 1346	33 x 30 mm	17.41 €



CUSHING



BT 1408	25 x 27 mm	19.71 €
---------	------------	---------

*Preturile sunt exprimate in Euro si nu includ TVA*

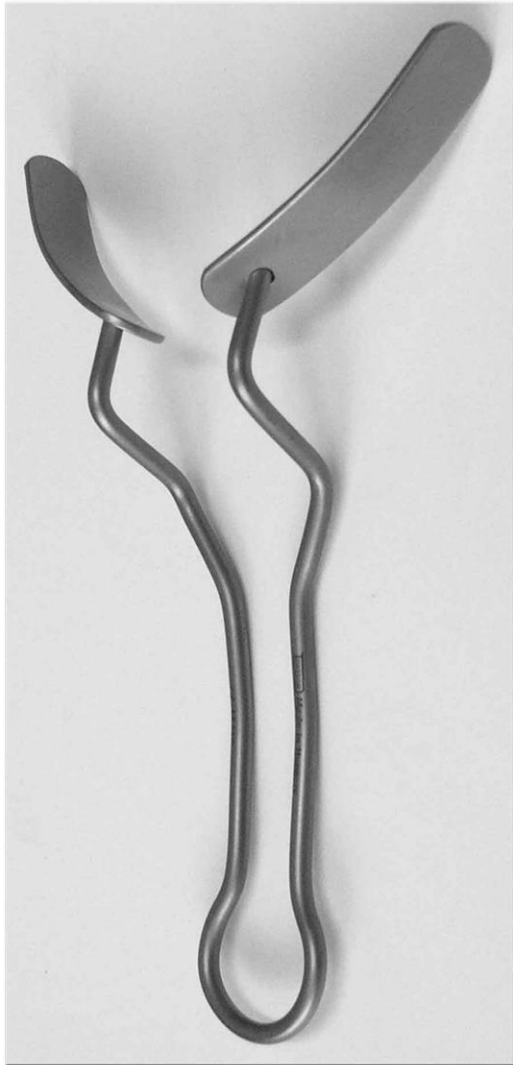
**DEPARTATOR VESTIBULAR**  
**VESTIBULUM HAKEN - VESTIBULUM RETRACTOR****VT 100**

SUS  
obere  
upper

32.66 €

**VT 101**

JOS  
untere  
lower

32.66 €

*Preturile sunt exprimate in Euro si nu includ TVA*

CHIURETE - SCHARFE LÖFFEL - BONE CURETTES

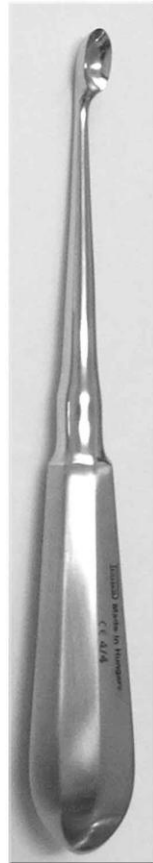

TIP VOLKMANN  
17 cm / 6<sup>3/4</sup>"

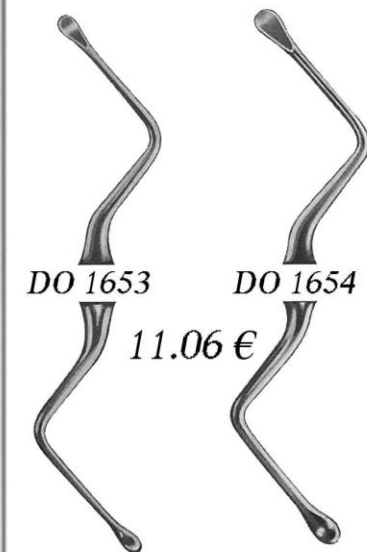

DO 1653 DO 1654  
11.06 €  
LINGURA LUKACS  
LUCAS SCHARFE LÖFFEL  
LUCAS BONE CURETTES



17.08 € 17.08 € 17.08 €  
1/1 1/1 1/1  
fig. 0000 fig. 000 fig. 00  
FK 1630 FK 1631 FK 1632  
2,3 x 3,5 3 x 4,6 4 x 6,2

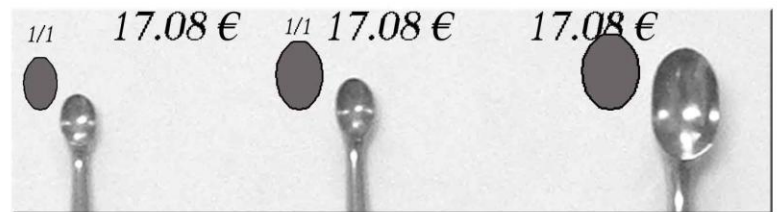

17.08 € 17.08 € 17.08 €  
1/1 1/1 1/1  
fig. 0 fig. 1 fig. 2  
FK 1633 FK 1634 FK 1635  
5 x 8 7 x 10,5 8,6 x 11,6

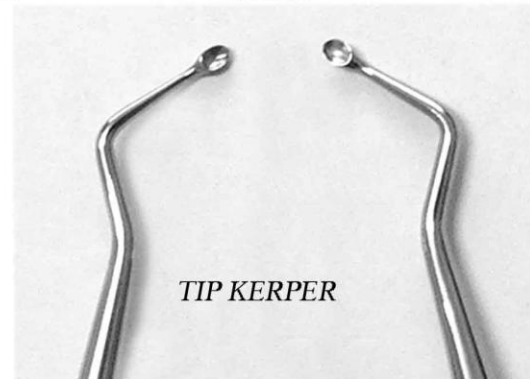

TIP KERPER



DO 1630  
2 x 3  
17.50 €



DO 1631  
2 x 3  
17.50 €

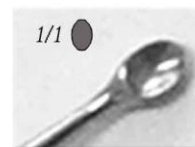

DO 1632  
2,5 x 4  
17.08 €



DO 1633  
2,5 x 4  
17.08 €

Preturile sunt exprimate in Euro si nu includ TVA

**CHIURETE ALVEOLARE DUBLE - SCHARFE LÖFFEL -  
BONE CURETTES  
(DOUBLE ENDED, CURVED)**

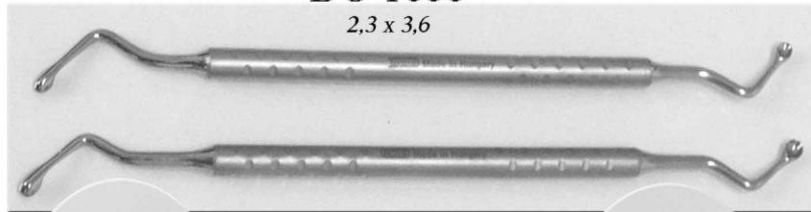

**DO 1655**  
2,3 x 3,6



**DO 1656**  
3 x 5  
16.67 €



**RAZUSTI  
RASPATORIES**

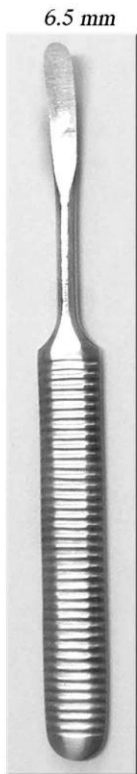

**FK 1300**

Williger



**FK 1301**

10.00 €

**FK 1800 FK 1801**

15.83 €



**BONT/ ASCUTIT**  
stumpf/ scharf  
blunt/ sharp

**FK 1164**  
2.5 mm

**FK 1165**  
4 mm

**FK 1166**  
6 mm



Freer

10.83 €



**FK 1611**  
5.00 €

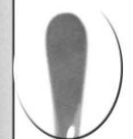

**FK 1612**  
5.00 €



Partsch

*Preturile sunt exprimate in Euro si nu includ TVA*

PORTACE - NADELHALTER - NEEDLE HOLDERS



BM 1234	13 cm	16.00 €
BM 1235	16 cm	17.00 €
BM 1236	18 cm	18.00 €
BM 1237	20 cm	19.00 €



BM 2234	13 cm	TC	31.67 €
BM 2235	16 cm	TC	37.08 €
BM 2236	18 cm	TC	39.58 €
BM 2237	20 cm	TC	41.25 €

30.00 €	BM 1360	14 cm
32.50 €	BM 1361	17 cm
35.00 €	BM 1362	20 cm



43.75 €	BM 2360	14 cm	TC
47.92 €	BM 2361	17 cm	TC
52.08 €	BM 2362	20 cm	TC

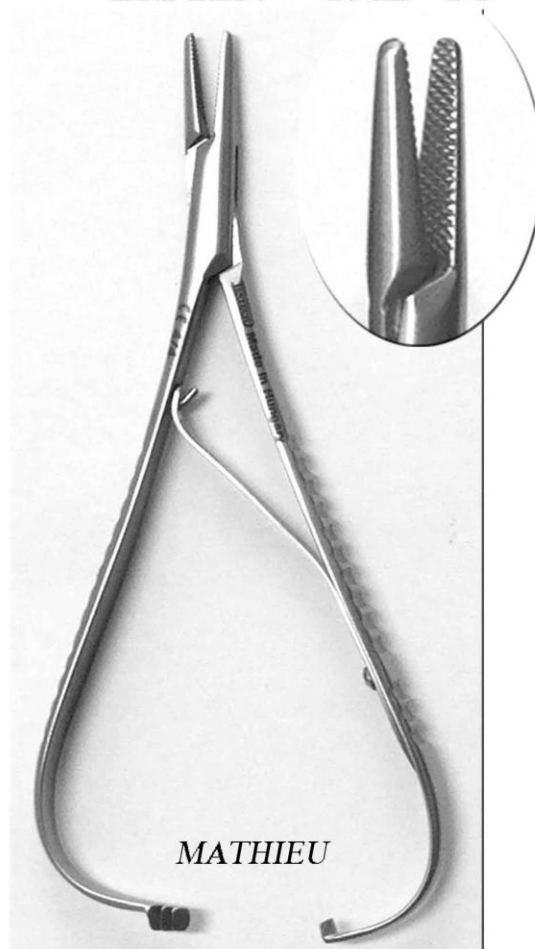

Preturile sunt exprimate in Euro si nu includ TVA

*SPATULA CIMENT -*

*ZEMENTSPATELN -*

*CEMENT SPATULAS  
DOUBLE-ENDED*

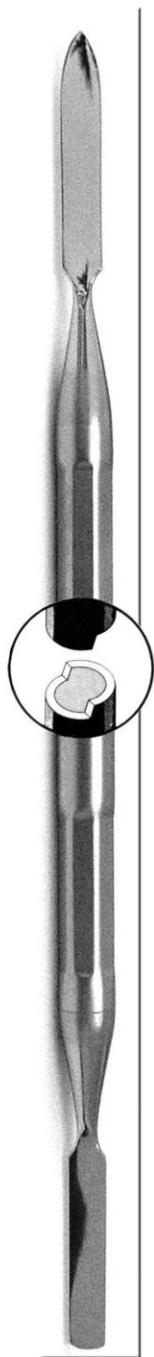

*.../HG*  
7.50 €



*DF 1150*  
6.25 €

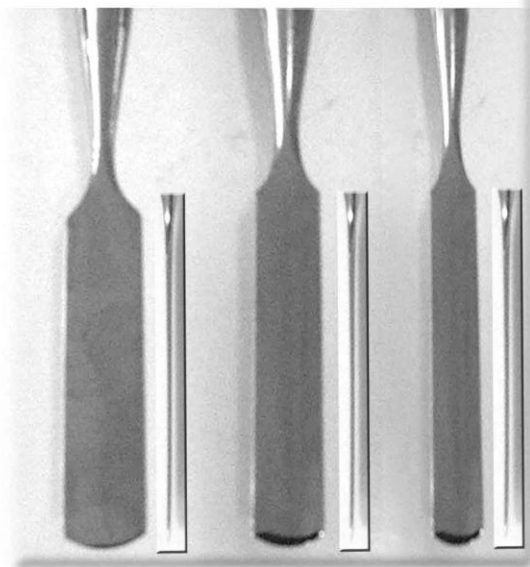
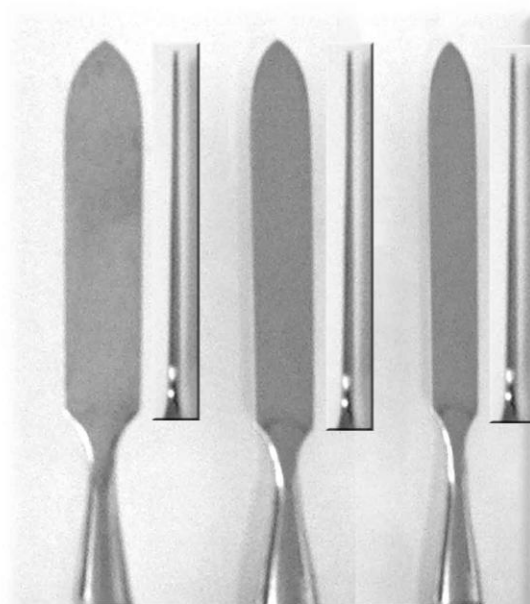

*DF 1165*    *DF 1163*    *DF 1161*  
6.25 €    6.25 €    6.25 €

*Preturile sunt exprimate in Euro si nu includ TVA*

**INSTRUMENTE MODELAJ COMPOZIT TITAN**  
**COMPOSITE FÜLLUNGSTRUMENTE MIT TITANNITRIDBESCHICHTUNG -**  
**COMPOSITE MODELLING INSTRUMENTS WITH TITANIUM NITRIDE**  
**NON-STICK PROTECTIVE COATING**



*Preturile sunt exprimate in Euro si nu includ TVA*

FULOARE - FÜLLUNGSINSTRUMENTE - FILLING INSTRUMENTS

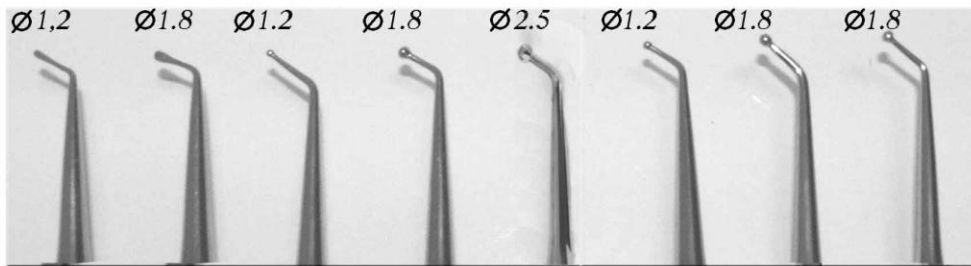

DE 14 DE 15 DE 16 DE 17 DE 20 DE 18 DE 19 DE 111 4.58 €

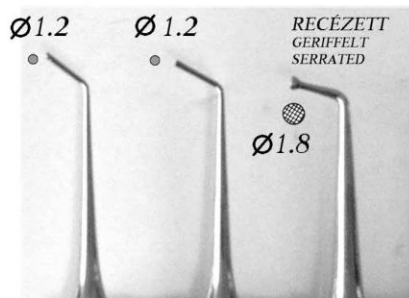
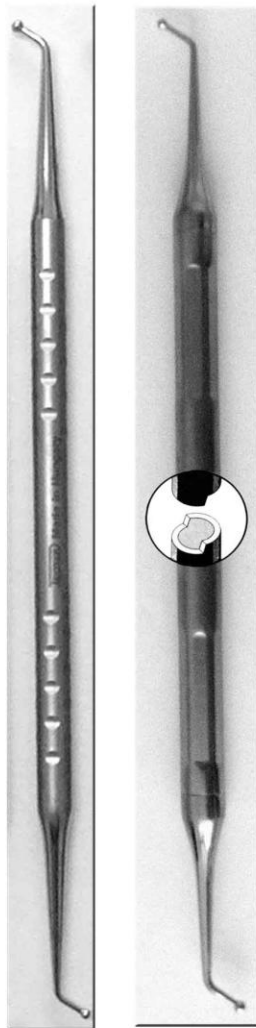
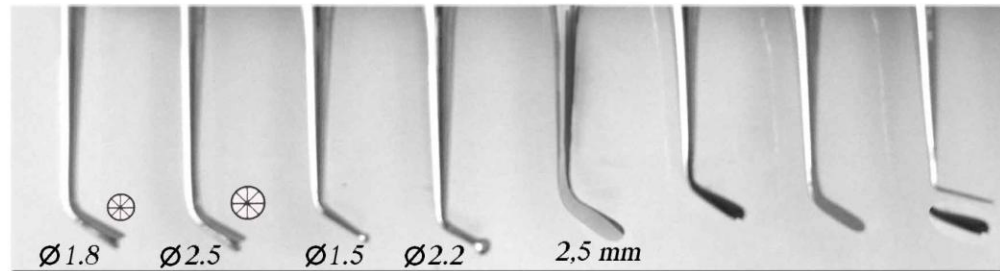

DE 124 DE 122 DE 1666 4.58 €

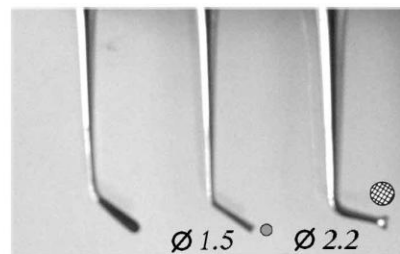

RECÉZETT  
GERIFFELT  
SERRATED

.../HG  
5.83 €

DE 17  
4.58 €

Preturile sunt exprimate in Euro si nu includ TVA



FULOARE - FÜLLUNGSINSTRUMENTE - FILLING INSTRUMENTS

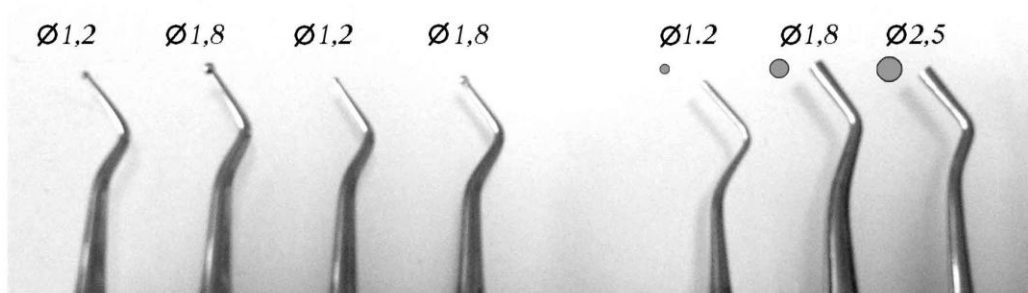

DE 1110 DE 1111 DE 1113 DE 1114 4.58 € DE 1125 DE 1126 DE 1127

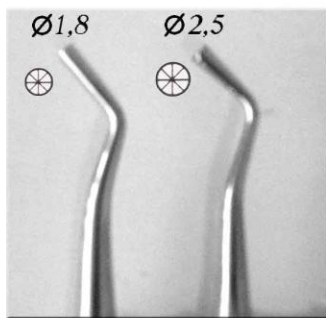
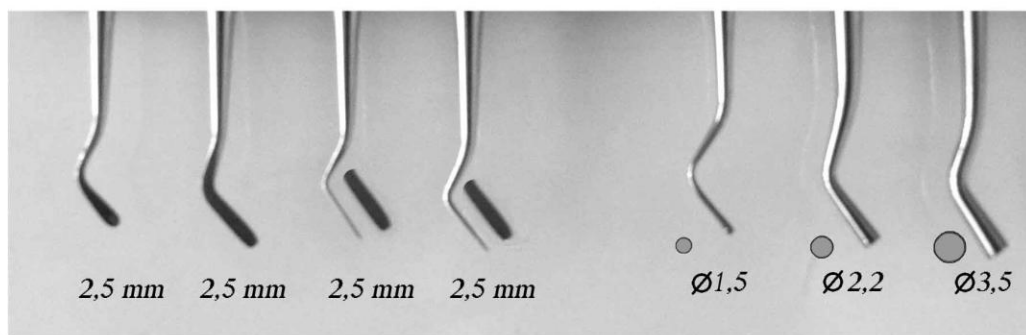

DE 1101 DE 1102

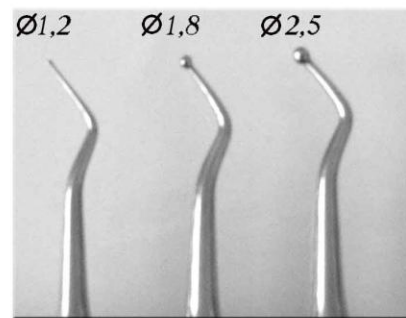

4.58 € DE 1107 DE 1108 DE 1109

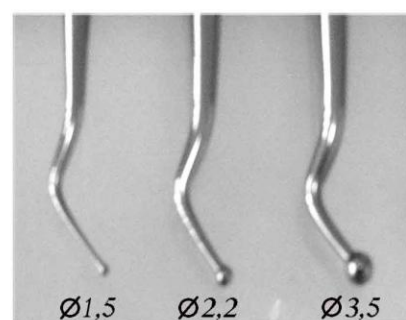
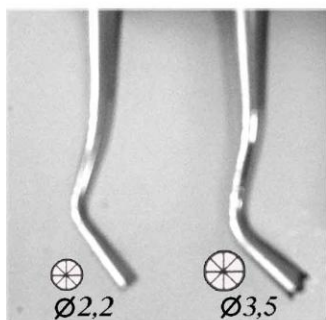

5.83 €

.../HG

Preturile sunt exprimate in Euro si nu includ TVA

**FULOARE - FÜLLUNGSINSTRUMENTE - FILLING INSTRUMENTS**

<b>SPATULA BUCALA</b>				<b>FULOARE</b>	
2,5 mm	2,5 mm	2 mm	2,5 mm	Ø1,8	Ø2,5
DE 1431 5.83 €	DE 1422 5.42 €	DE 1421 5.42 €	DE 1423 5.83 €	DF 121 4.58 €	DF 122 4.58 €
				Ø2,5	Ø3,5
FOSTER-FLAGG	HEIDEMANN	BÜCHS			

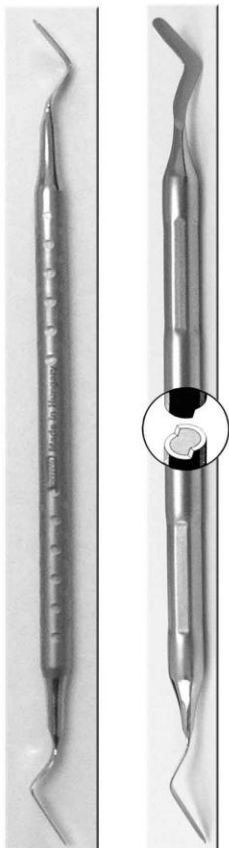

**FULOARE**

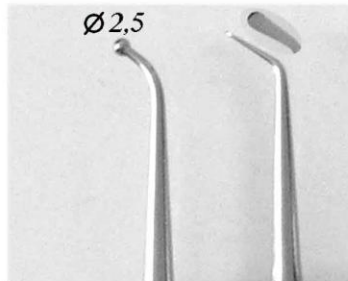

DE 1297 4.58 €    DE 130 4.58 €

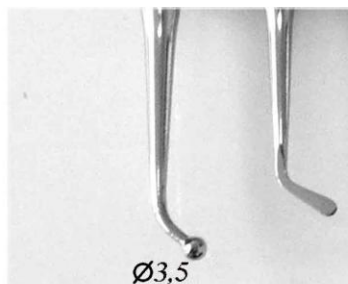

.../HG 5.83 € Preturile sunt exprimate in Euro si nu includ TVA

PLAGARE -

NERVEN INSTRUMENTE - NERVE INSTRUMENTS

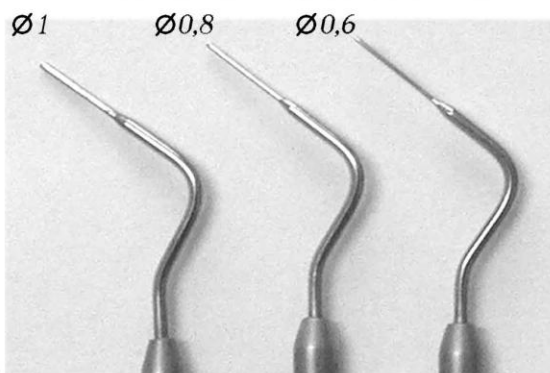

DD 9  
3.33 €

DD 8  
3.33 €

DD 7  
3.33 €

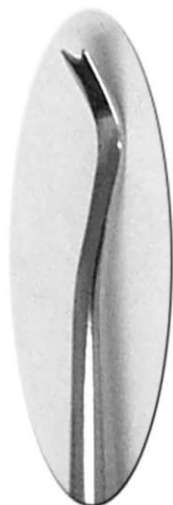

DO 1305

APLICATOR  
RULOURI  
CURB TIP  
BUCKS

5.83 €



DO 1301

APLICATOR  
RULOURI  
DREPT TIP  
LUNATSCHEK

5.83 €



Luniatschek  
18.5 cm / 7<sup>1</sup>/<sub>4</sub>"  
TAMPONSTOPFER  
GAUZE PACKER

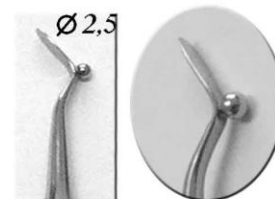

Ø2,5



Ø1,8

Vajna  
DF 100  
9.58 €

SPATULA FULOAR TIP VAJNA  
FÜLLUNGSINSTRUMENTE  
FILLING INSTRUMENTS

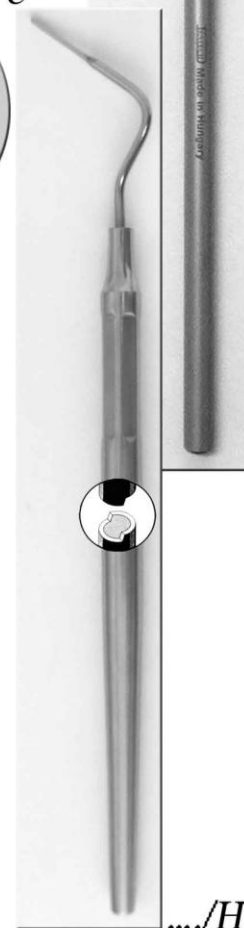

.../HG

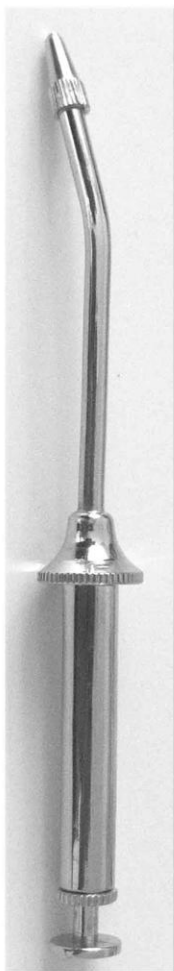

**DF 116**  
PISTOL AMALGAM  
AMALGAM PISTOLE  
AMALGAM CARRIERS  
9.94 €

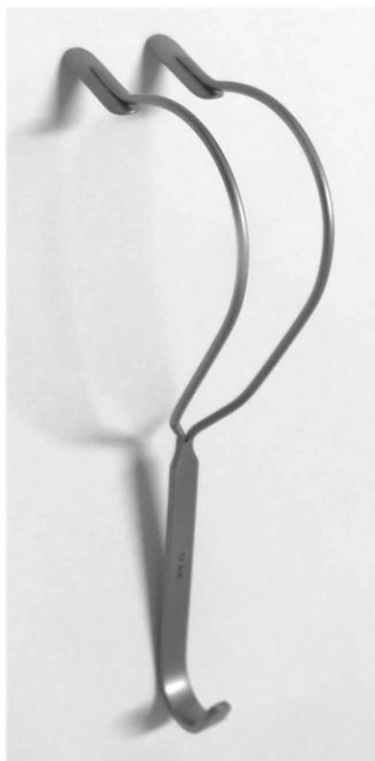

**DD 10**  
MENTINATOR RULOURI  
WATERROLLENHALTER  
COTTON PUSHER  
10.83 €



**DO 1306**  
APLICATOR FIRE  
FADENSTOPFER  
RETRACTION  
PACKER  
6.67 €



**DF 1346** 5 mm  
**DF 1348** 7 mm  
PORT MATRICE TOFLEMIRE  
MATRIZEN SPANNER  
MATRIX RETAINERS

8.17 €



**DF 1349**  
PORTMATRICE IVORY  
MATRIZEN SPANNER  
MATRIX RETAINERS IVORY

11.08 €

Preturile sunt exprimate in Euro si nu includ TVA

**EXCAVATOARE - EXKAVATOREN - EXCAVATORS**



.../HG

6.67 €

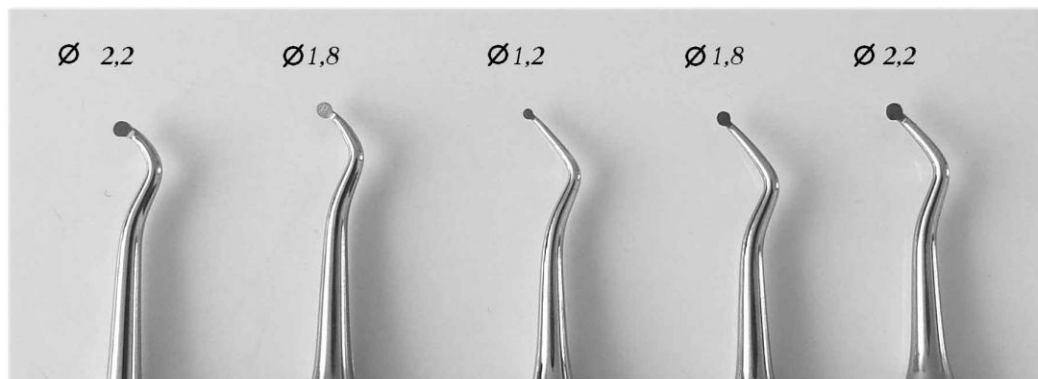

DC 1239  
5.42 €

DC 1241  
5.42 €

DC1271  
5.42 €

DC 1275  
5.42 €

DC1279  
5.42 €

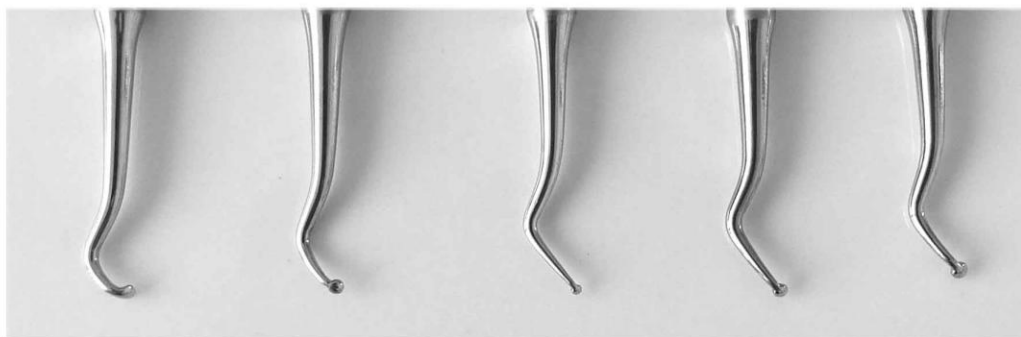

OM 13



OM 12



OM 11

PROTECTIE DEGETE  
FINGERSCHÜTZER, METALL 19.17 €  
FINGER PROTECTOR

*Preturile sunt exprimate in Euro si nu includ TVA*

**INSTRUMENT GINGIVAL DE MANA -**

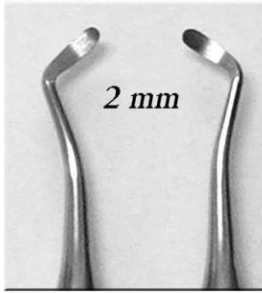

DC 161 DC 162

4.17 €

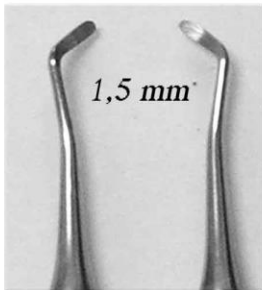

DC 163 DC 164

4.17 €

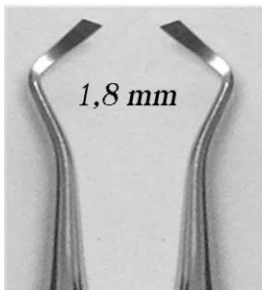

DC 177 DC 178

4.17 €

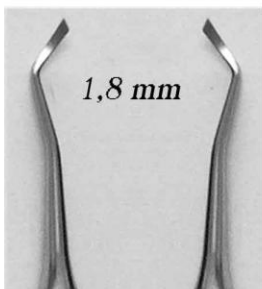

DC 179 DC 180

4.17 €

ZAHNFLEISCHMESSER  
BLACK CUTTING  
INSTRUMENTS

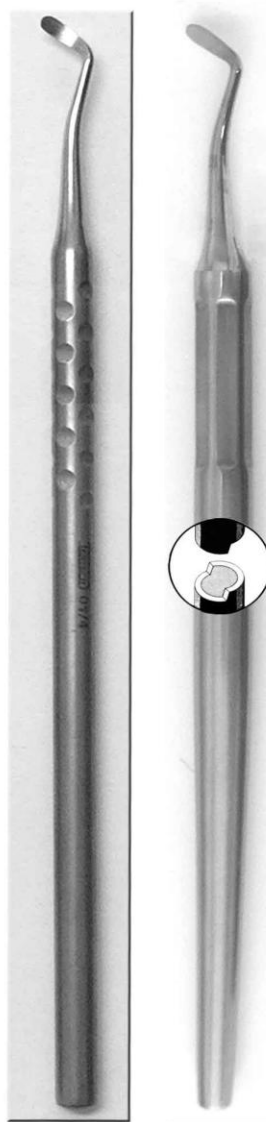

.../HG

6.13 €

**DALTITA DE SMALT- SCHMELZMEISSEL  
ENAMEL CHISELS**

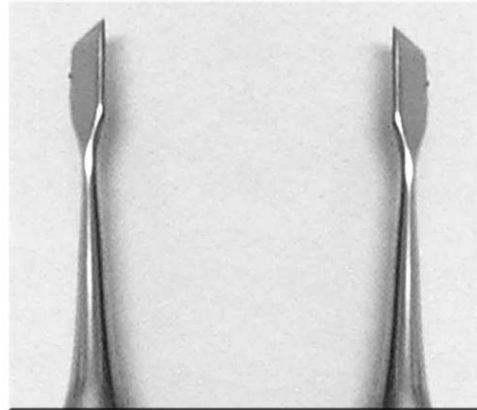

DC 151 3 mm DC 152

4.17 €

4.17 €

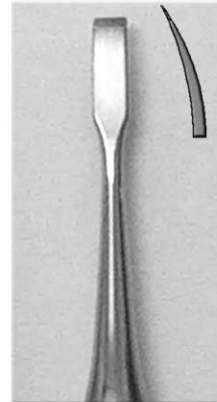

DC 181 3 mm

4.17 €

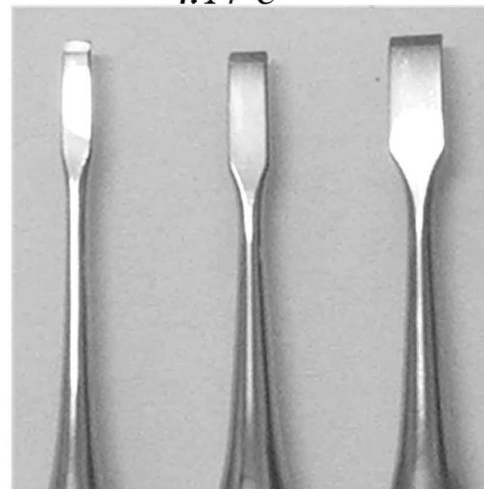

DC 185

DC 184

DC 183

2 mm

3 mm

4 mm

4.17 €

4.17 €

4.17 €

*Preturile sunt exprimate in Euro si nu includ TVA*

**PENSE HEMOSTATICE - ARTERIENKLEMMEN - HAEMOSTATIC FORCEPS**

- 11.25 € BH 1613 12.5 cm
- 13.33 € BH 1615 14 cm
- 14.17 € BH 1643 16 cm
- 15.42 € BH 1645 18 cm

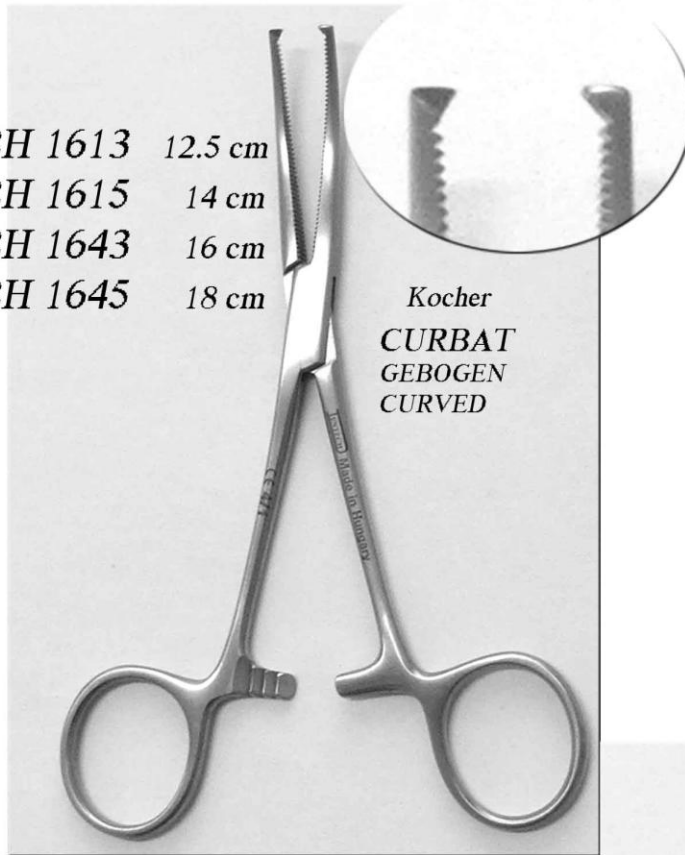

Kocher  
CURBAT  
GEBOGEN  
CURVED

- 10.83 € BH 1612 12.5 cm
- 12.50 € BH 1614 14 cm
- 13.33 € BH 1642 16 cm
- 14.58 € BH 1644 18 cm

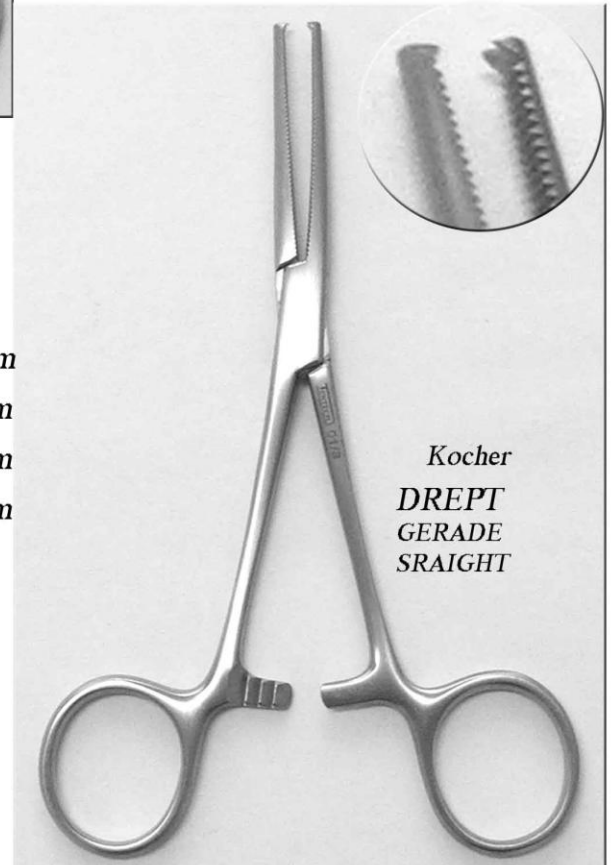

Kocher  
DREPT  
GERADE  
STRAIGHT

*Preturile sunt exprimate in Euro si nu includ TVA*

36.

**PENSE HEMOSTATICHE - ARTERIENKLEMMEN - HAEMOSTATIC FORCEPS**

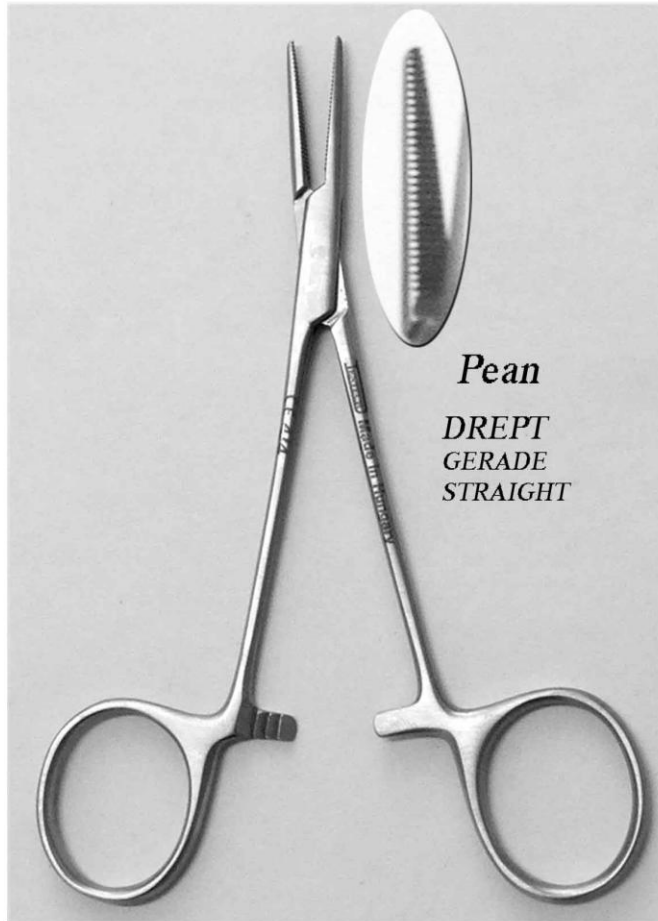

BH 1420	10 cm	9.58 €
BH 1422	12.5 cm	10.42 €
BH 1424	14 cm	11.25 €
BH 1442	16 cm	12.50 €
BH 1444	18 cm	13.75 €

10.00 €	BH 1421	10 cm
10.83 €	BH 1423	12.5 cm
12.08 €	BH 1425	14 cm
12.92 €	BH 1443	16 cm
14.58 €	BH 1445	18 cm

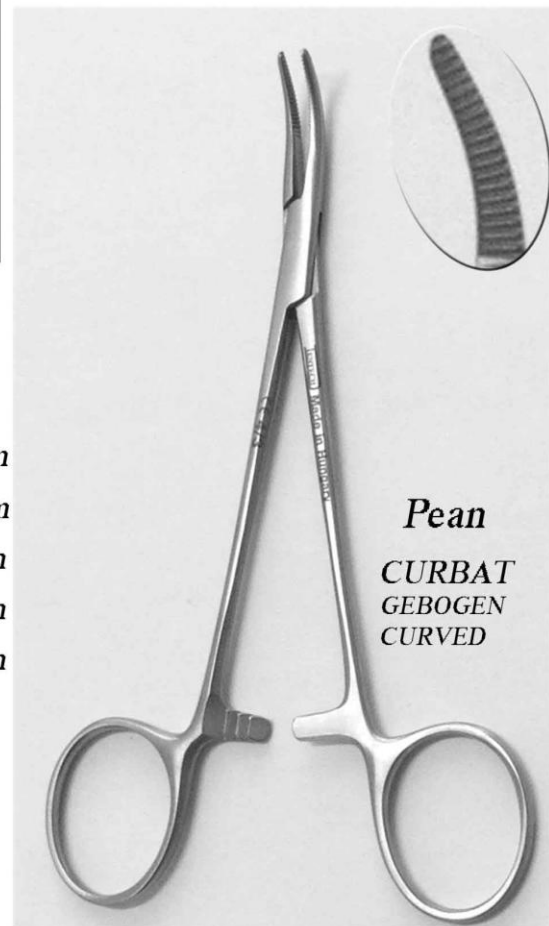

*Preturile sunt exprimate in Euro si nu includ TVA*



*BISTURIE - AUGENSKAPPELLE - SCALPELS*

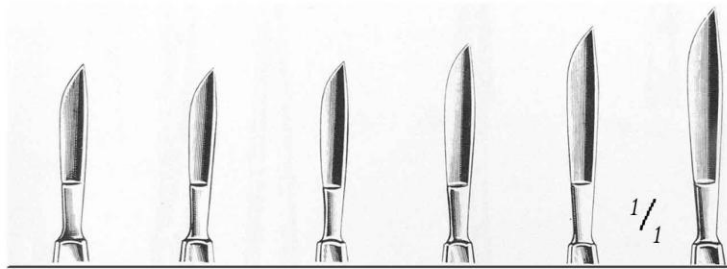

BA 1401 BA 1402 BA 1403 BA 1404 BA 1407 BA 1408

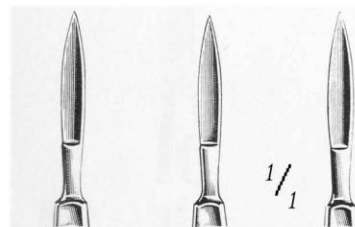

BA 1409 BA 1410 BA 1411

*BISTURIE OFTALMOLOGICE*

6.41 €

*BISTURIE CHIRURGICALE - CHIRURGISCHE SKAPPELLE - SURGERY KNIVES*

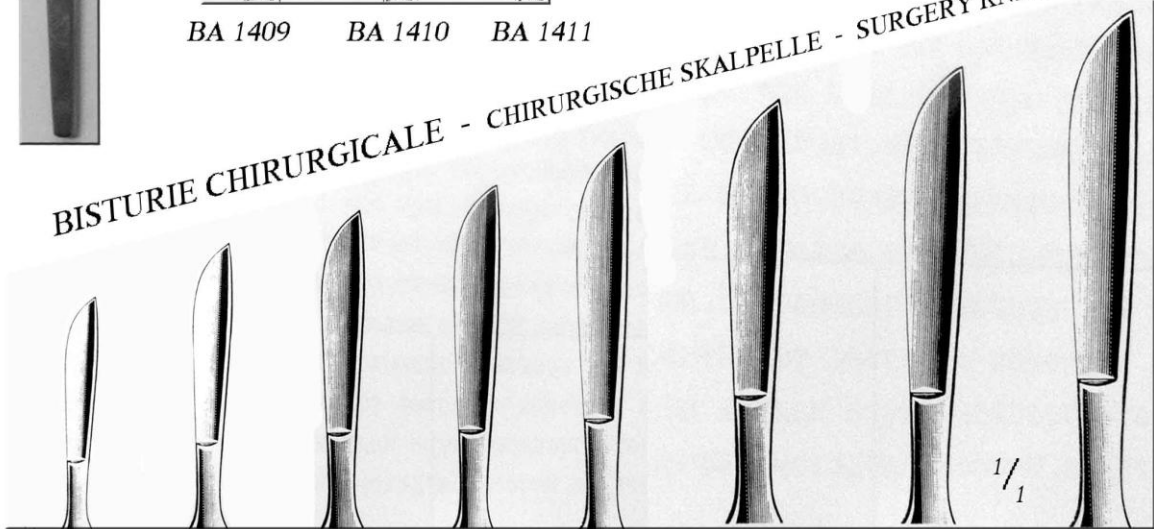

BA 1501 BA 1502 BA 1503 BA 1504 BA 1505 BA 1507 BA 1508 BA 1509

7.34 €

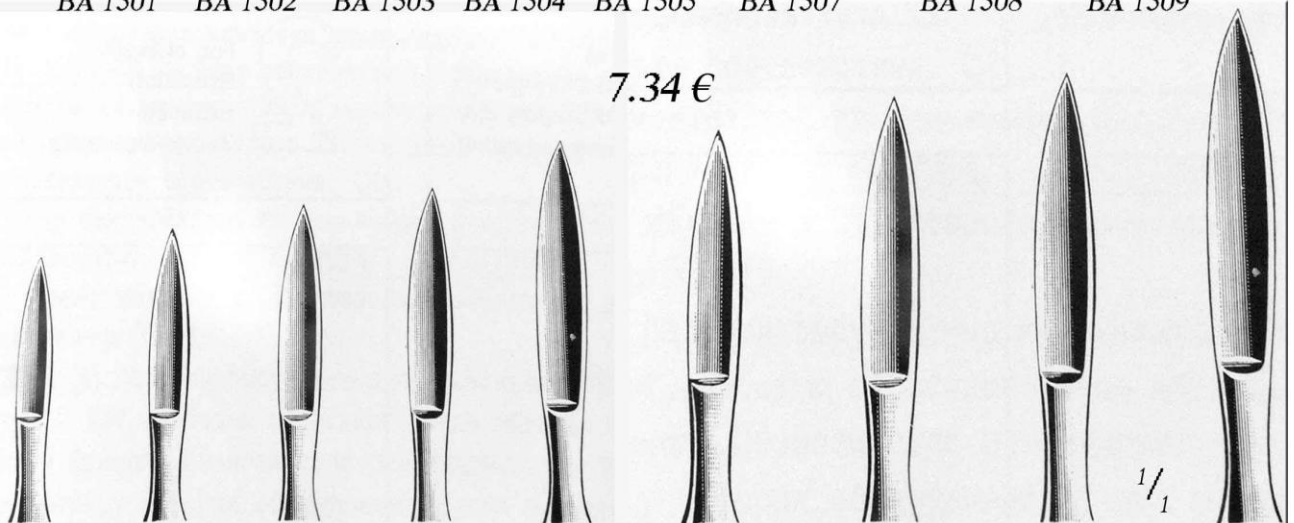

BA 1510 BA 1511 BA 1512 BA 1513 BA 1514 BA 1515 BA 1516 BA 1517 BA 1518

*Preturile sunt exprimate in Euro si nu includ TVA*

DG50/...

DG40/....

CLESTI EXTRACTIE - ZAHNZANGE - EXTRACTING FORCEPS

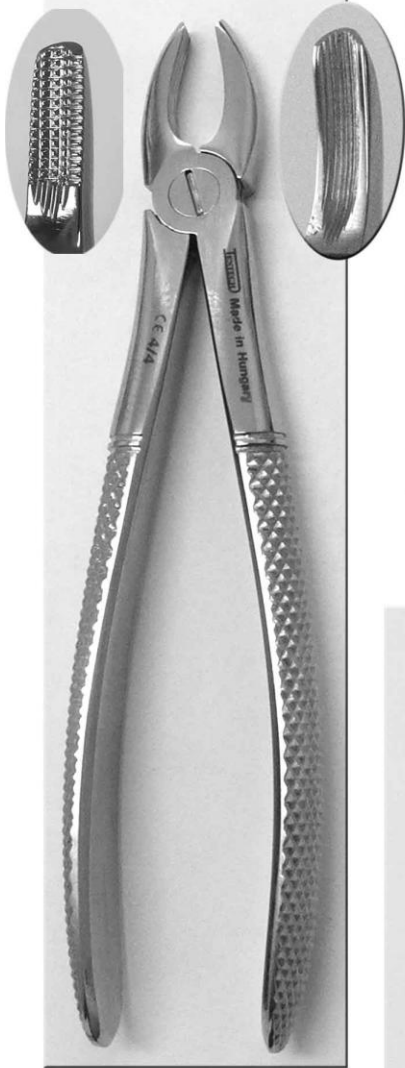

1  
28.50 €



2  
28.50 €

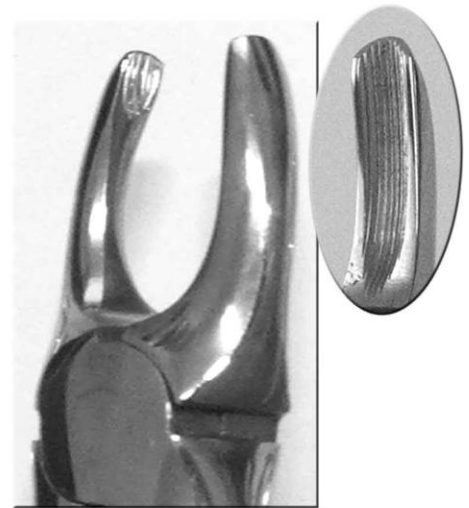

3  
28.50 €



7  
28.50 €



8  
28.50 €



13 28.50 €

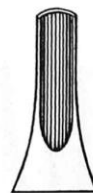

4 28.50 €

Preturile sunt exprimate in Euro si nu includ TVA

CLESTI EXTRACTIE - ZAHNZANGE - EXTRACTING FORCEPS



18  
28.50 €

DG 40/...



18 A  
28.50 €



17  
28.50 €



22  
28.50 €



19  
28.50 €



20  
28.50 €



21 28.50 €

*Preturile sunt exprimate in Euro si nu includ TVA*

40.

CLESTI EXTRACTIE - ZAHNZANGE - EXTRACTING FORCEPS

DG 40/...



29

28.50 €

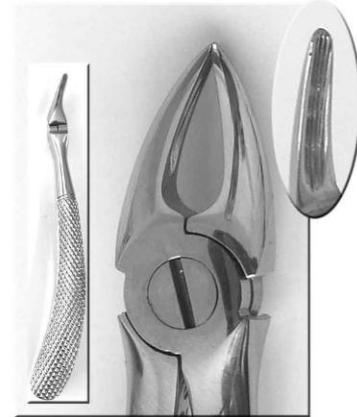

30

28.50 €



23



24

28.50 €

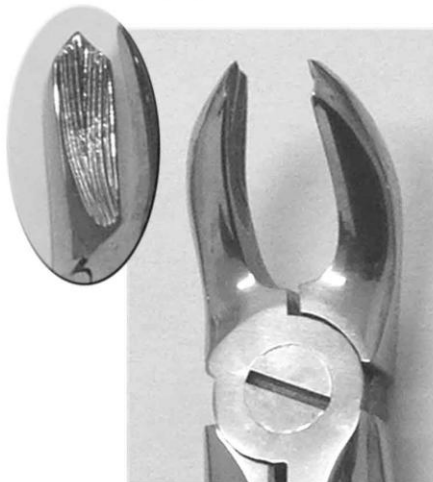

32

28.50 €



31

28.50 €

*Preturile sunt exprimate in Euro si nu includ TVA*

CLESTI EXTRACTIE - ZAHNZANGE - EXTRACTING FORCEPS

DG 40/...



52 A

28.50 €



51 A

28.50 €



51

28.50 €



52

28.50 €



51 L

28.50 €



51 W



56

28.50 €



55

28.50 €



67

*Preturile sunt exprimate in Euro si nu includ TVA*

42.

**DG 40/...** CLESTI EXTRACTIE - ZAHNZANGE - EXTRACTING FORCEPS

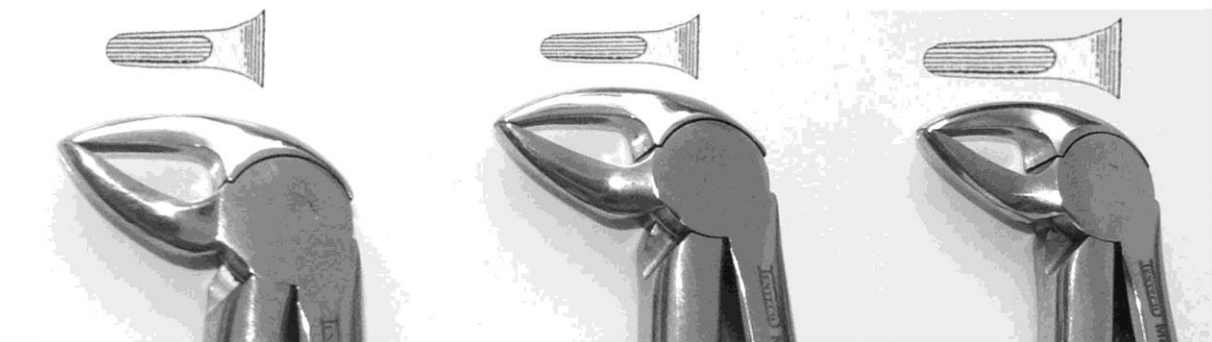

33

33 A

33 B

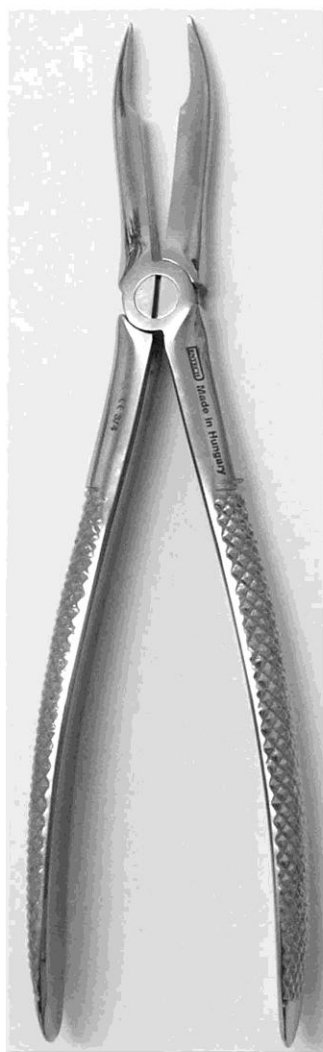

33 W



33 1/2

28.50 €



41

44



45

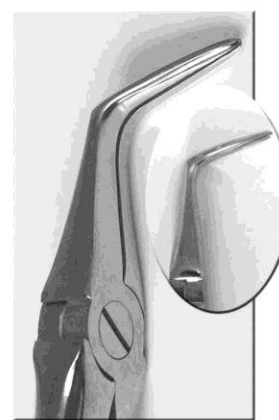

46 LX

DECOLORATOR GINGIVAL  
ZAHNFLEISCHABTRENNER  
SPECIAL GUM KNIFE

DD 11

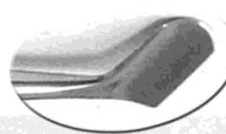

8.33 €

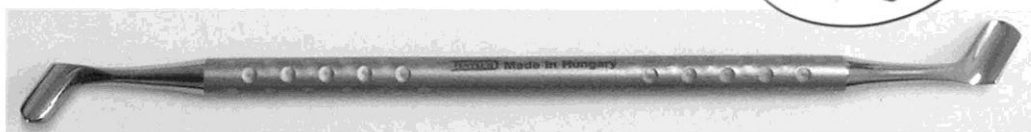

*Preturile sunt exprimate in Euro si nu includ TVA*

CLESTI EXTRACTIE - ZAHNZANGE - EXTRACTING FORCEPS

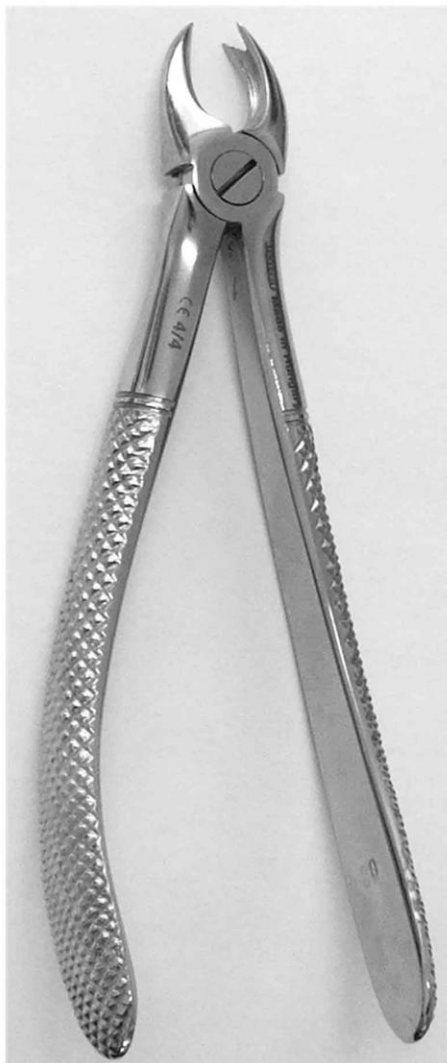

DG 40/...



89  
28.50 €

90  
28.50 €



79  
28.50 €

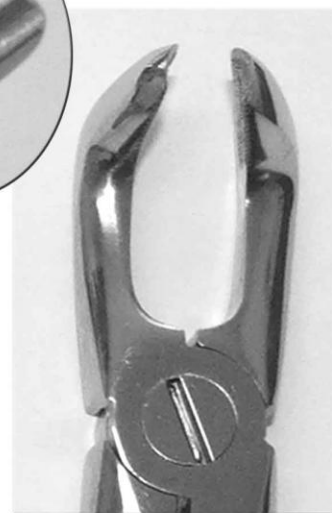

79 A  
28.50 €

*Preturile sunt exprimate in Euro si nu includ TVA*

44.

CLESTI EXTRACTIE COPII - KINDER ZAHNZANGE -  
EXTRACTING FORCEPS FOR CHILDREN

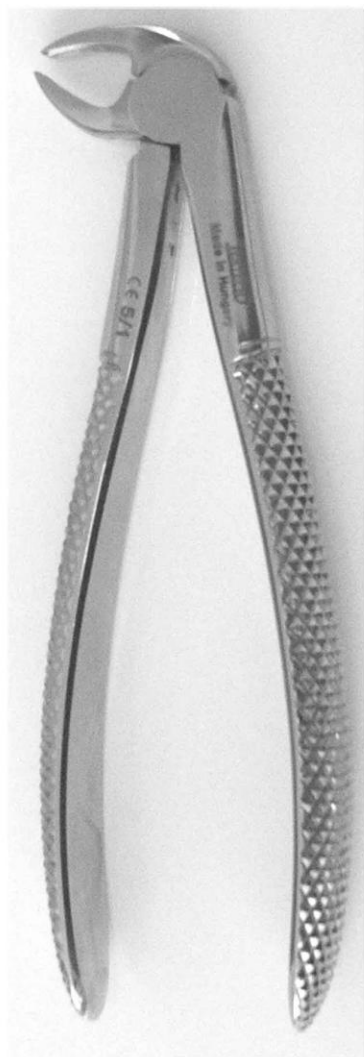

13 S 28.50 €



33 S

28.50 €



DG 40/...



22 S

28.50 €



38

28.50 €



37 28.50 €



28.50 €



Preturile sunt exprimate in Euro si nu includ TVA



CLESTI DE EXTRACTIE COPII - KINDER ZAHNZANGE - EXTRACTING FORCEPS FOR CHILDREN

DG 40/...

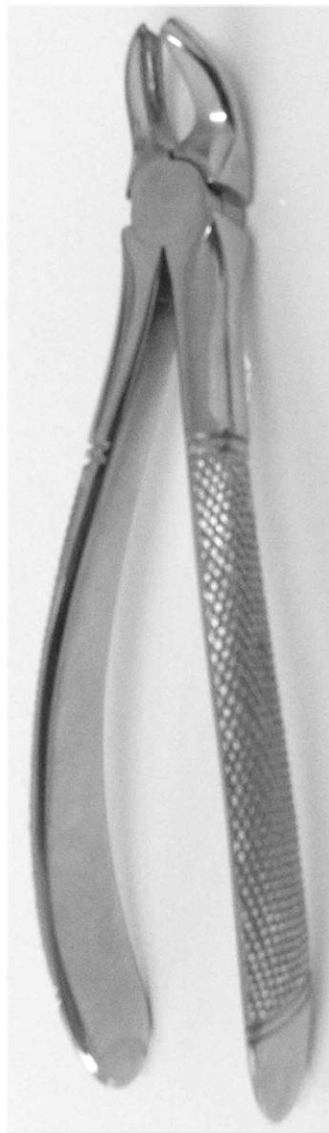

39 R  
28.50 €



39 L  
28.50 €

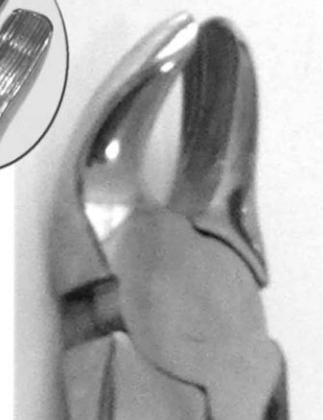

39  
28.50 €



30 S  
28.50 €

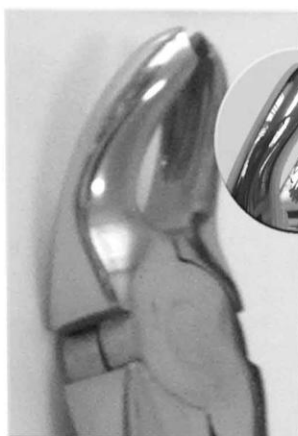

39 A  
28.50 €

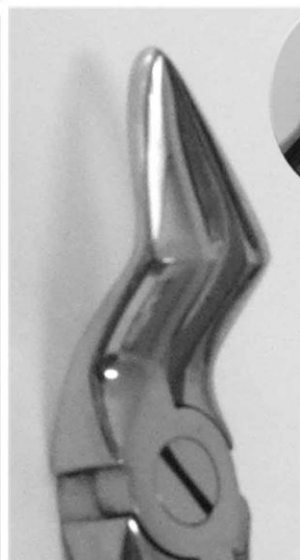

51 S 28.50 €

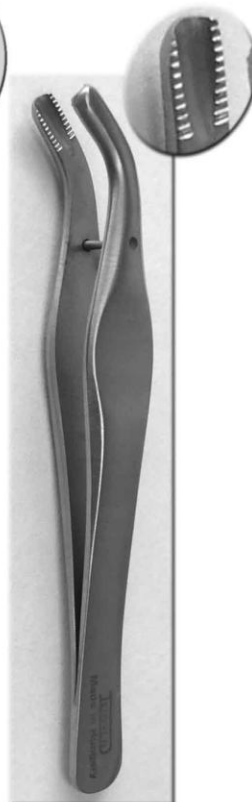

DG 40 / 100  
10.83 €

PENSA PENTRU DINTI  
DE LAPTE  
MILCHZAHNPINZETTE  
TWEezer FOR CHILDREN

Preturile sunt exprimate in Euro si nu includ TVA

46.

CLESTI DE EXTRACTIE COPII - KINDER ZAHNZANGE - EXTRACTING FORCEPS FOR CHILDREN



DK 901



DK 899



28.50 €

DK 897



DK 895



DK 910



DK 903



DK 905

Preturile sunt exprimate in Euro si nu includ TVA

## **CLESTI EXTRACTIE**

Fig. 1	Pentru incisivii și caninii superiori
Fig. 2	Pentru incisivii laterali
Fig. 3	Pentru incisivii superiori
Fig. 4	Pentru incisivii inferiori
Fig. 7	Pentru premolarii superiori
Fig. 8	Pentru premolarii inferiori
Fig. 13	Pentru premolarii și caninii inferiori
Fig. 17	Pentru molarii din dreapta superiori
Fig. 18	Pentru molarii din stânga superiori
Fig. 18A	Pentru molarii superiori din ambele părți
Fig. 19	Pentru molarii și măseaua de minte
Fig. 20	Pentru măseaua de minte inferioară, ambele părți
Fig. 21	Pentru molarii inferiori și măseaua de minte
Fig. 22	Pentru molarii inferiori, ambele părți
Fig. 23	Pentru molar inferior, parte dreaptă
Fig. 24	Pentru molar inferior, partea stângă
Fig. 29	Pentru incisivii superiori și rădăcină de canin
Fig. 30	Pentru rădăcină superioară
Fig. 31	Pentru premolar inferior și rădăcină
Fig. 32	Pentru molar inferior, ambele părți
Fig. 33	Pentru premolar inferior și rădăcină
Fig. 33A	Pentru rădăcină inferioară, cu față îngustă
Fig. 33B	Pentru rădăcină inferioară, cu fața îngustă alungită
Fig. 33 ½	Pentru radacina inferioara
Fig. 33 W	Pentru radacina inferioara
Fig. 41	Pentru rădăcină superioară, ambele părți, cu fața dreaptă
Fig. 44	Pentru rădăcină superioară, ambele părți, cu fața arcuită
Fig. 45	Pentru rădăcină inferioară, ambele părți
Fig. 46 LX	Pentru radacina inferioara
Fig. 51	Pentru rădăcină superioară
Fig. 51 A	Pentru rădăcină superioară, cu fața îngustă
Fig. 51W	Pentru radacina superioara
Fig. 52	Pentru rădăcină superioară, cu fața lată și scurtă
Fig. 52A	Pentru rădăcină superioară, cu fața lată și lungă
Fig. 55	Separator de molari superiori
Fig. 56	Separator de molari inferiori
Fig. 67A	Pentru măseaua de minte superioară
Fig. 79	Pentru măseaua de minte inferioară, cu fața ascuțită
Fig. 79A	Pentru măseaua de minte inferioară, cu fața arcuită
Fig. 89	Pentru molar superior, partea dreaptă, cu prindere adâncă
Fig. 90	Pentru molar superior, partea stângă, cu prindere adâncă

### **CLESTI EXTRACTIE PENTRU COPII**

Fig. 13S	Pentru incisivi și premolari inferiori
Fig. 22S	Pentru molari inferiori
Fig. 29S	Pentru incisivi superiori și rădăcină de canin, ambele părți
Fig. 30S	Pentru rădăcină de incisivi superiori
Fig. 33S	Pentru premolari inferiori și rădăcină
Fig. 37	Pentru incisiv superior
Fig. 38	Pentru incisivi inferiori
Fig. 39	Pentru molarii superiori, ambele părți
Fig. 39A	Pentru molarii superiori, ambele părți, cu fața ascuțită
Fig. 39L	Pentru molarii superiori, partea stângă
Fig. 39R	Pentru molarii superiori, partea dreaptă
Fig. 51S	Pentru rădăcină superioară

### **CLESTI EXTRACTIE PENTRU COPII TIPUL KLEIN**

DK895	Pentru incisivii superiori
DK897	Pentru premolarii superiori
DK899	Pentru radacina superioara
DK901	Pentru molarii superiori
DK903	Pentru radăcină inferioara
DK905	Pentru incisivii si premolarii inferiori
DK910	Pentru molarii inferiori

INDEPARTATOR RESTURI RADACINA  
WURZELSPITZENHEBER  
ROOT TIP PICKS

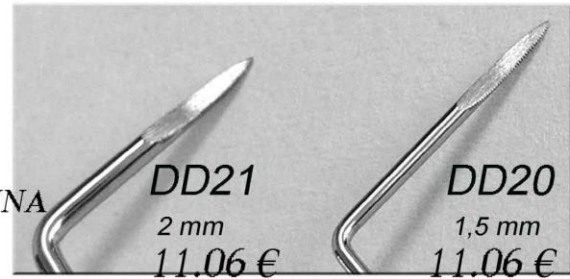

*Luxator - Luxator -*

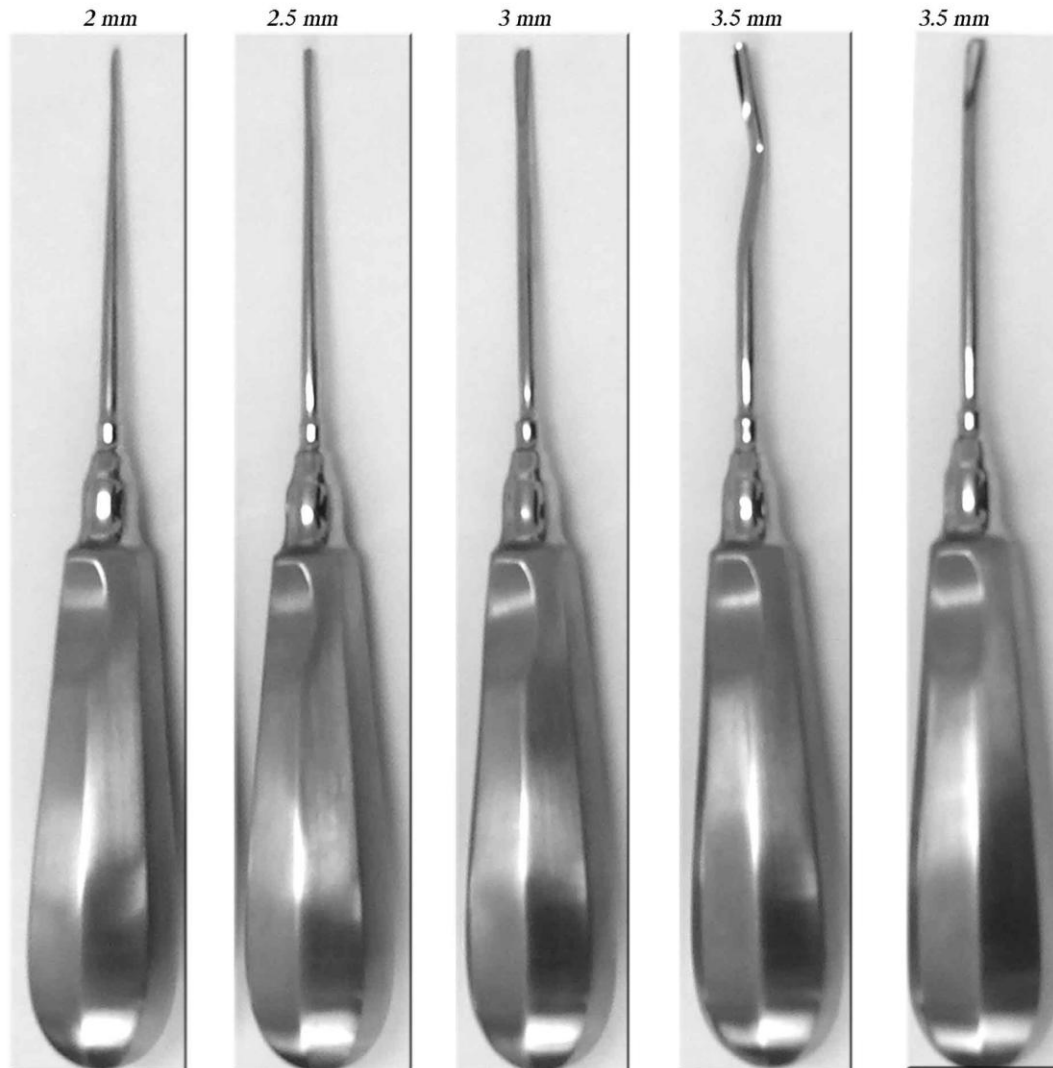

21.70 €

LX 120    LX 125    LX 130    LX 135    LX 136

*Preturile sunt exprimate in Euro si nu includ TVA*



MT 110 110 gr 20.83 €  
 MT 180 180 gr 25.00 €

CIOCAN METALIC CU INSERTI DE TEFLON  
 HAMMER MIT TEFLON EINSATZ  
 MALLETS WITH TEFLON INSERT



MS 110 110 gr 16.67 €  
 MS 180 180 gr 19.17 €

CIOCAN METALIC  
 HAMMER AUS METALL  
 MALLETS STAINLES STEEL

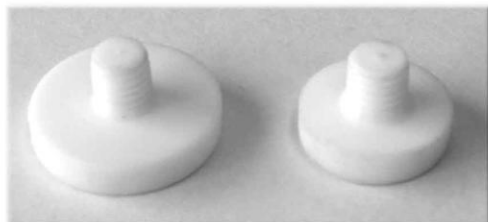

MT 111 d=20 mm 3.17 €  
 MT 181 d=25 mm 3.57 €

CAPETE DE TEFLON  
 TEFLON EINSATZ  
 TEFLON INSERT

*Preturile sunt exprimate in Euro si nu includ TVA*

**DALTI PLANE -**

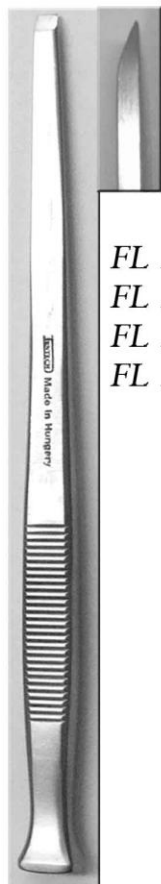

FL 1183 3 x 2 mm  
FL 1184 4 x 2,5 mm  
FL 1185 5 x 3 mm  
FL 1186 6 x 3 mm

10.83 €

**Partsch**

17 cm / 6 3/4 "

**FLACHMEISSEL -**

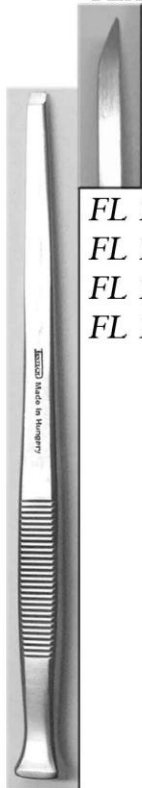

FL 1173 3 x 2 mm  
FL 1174 4 mm  
FL 1175 5 x 2,4 mm  
FL 1176 6 x 2,6 mm

10.00 €

**Partsch**

14 cm / 5 1/2 "

**BONE CHISELS AND GOUGES**

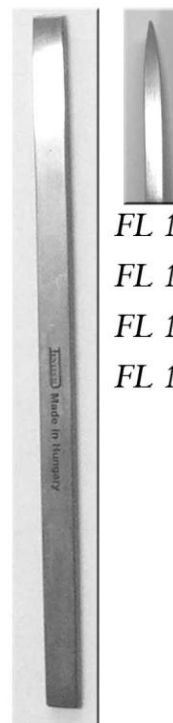

FL 1101 4 x 2,3 mm 5.83 €  
FL 1102 6 x 2,3 mm 6.25 €  
FL 1104 8 x 2,3 mm 6.67 €  
FL 1106 10 x 2,3 mm 7.08 €

**Lambotte**

13.00 €



DD2 2 mm  
DD3 3 x 2,2 mm  
DD4 4 x 2,4 mm  
DD5 5 x 2,6 mm  
DD6 6 x 2,8 mm

10.00 €

**Moczár**  
15 cm



12.50 €  
17 cm

FL 1223  
FL 1224  
FL 1225  
FL 1226

**DALTA SCOBITA**  
HOHLMEISSEL  
GOUGES



3 mm  
4 mm  
5 mm  
6 mm

11.67 €  
14 cm / 5 1/2 "

FL 1213  
FL 1214  
FL 1215  
FL 1216



FL 1124 4mm  
FL 1126 6mm

**DALTA PLANA CUDAT IN**  
BAIONETA  
BAJONETT-FÖRMIG  
BOE -CHISELS  
BAYONET-SHAPED

*Preturile sunt exprimate in Euro si nu includ TVA*

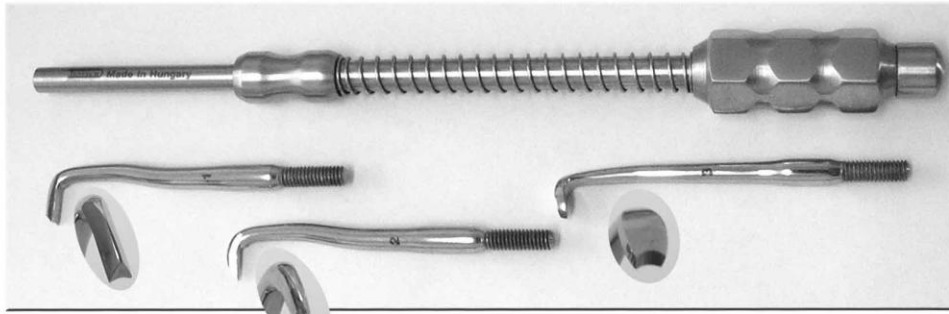

**DP 1780**  
INDEPARTATOR LUCRARI PROTETICE  
" SZTRILICH " ( 3 CAPETE)  
KRONENABNEHMER MIT FEDERN | SZTRILICH |  
CROWN REMOVERS **37.00 €**

CAP PENTRU 1781  
KOPF FÜR DP 1781  
HEAD FOR DP 1781

DP 1781/3-1   DP 1781/3-2   DP 1781/3-3  
**6.00 €   6.00 €   6.00 €**



**DP 1781**  
INDEPARTATOR UNIVERSAL LUCRARI PROTETICE  
UNIVERSAL KRONENENTFERNER  
UNIVERSAL CROWN REMOVER **120.00 €**

**DP 1781/5** 195 mm  
BOWDEN LUNG PENTRU  
DP 1781  
SCHLINGE LANG  
FÜR DP 1781 **9.00 €**  
LOOP LONG  
FOR DP 1781

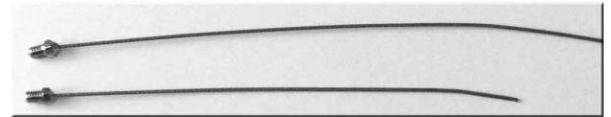

**DP 1781/4** 85 mm  
BOWDEN SCURT PENTRU  
DP 1781 **8.50 €**  
SCHLINGE KURZ  
FÜR DP 1781  
LOOP SHORT  
FOR DP 1781



**DP 1781/2**  
BUCLA DUBLA PENTRU  
A DP 1781 **55.00 €**  
DOPPELSCHLAUFENSYTEM  
FÜR DP 1781  
DOUBLE LOOP TIP FOR DP 1781



**DP 1781/1**  
BUCLA SIMPLA PENTRU  
DP 1781 **37.50 €**  
EINZELSCHLAUFENSYTEM  
FÜR DP 1781  
SIMPLE LOOP TIP FOR DP 1781

Preturile sunt exprimate in Euro si nu includ TVA





**DP1783**  
FOARFECA DESCHIZATOR COROANE  
KRONENABNEHMER-SCHERE  
CROWN REMOVERS SCISSORS 19.50 €



**DP 1784**  
DESCHIZATOR COROANE  
KRONENENABNEHMER  
CROWN REMOVER  
22.50 €

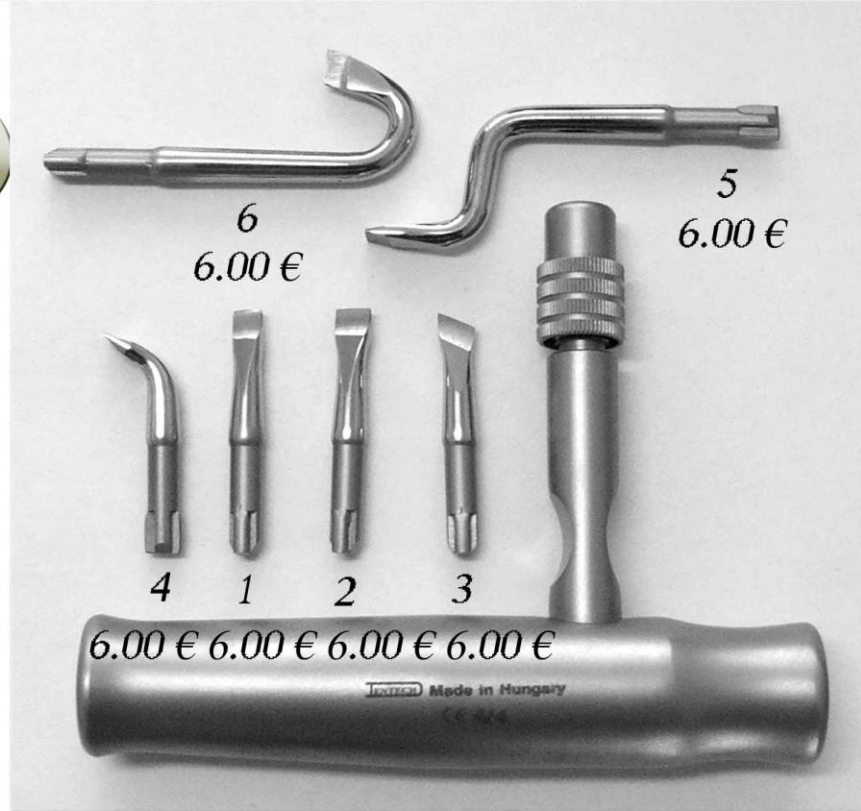

**DP 1779**  
INSTRUMENT INDEPARTATOR LUCRARI PROTETICE  
TIP DENTECH ( 6 CAPETE )  
KRONENENTFERNER MIT 6 EINSATZEN  
CROWN REMOVERS WITH 6 INSERT 84.50 €

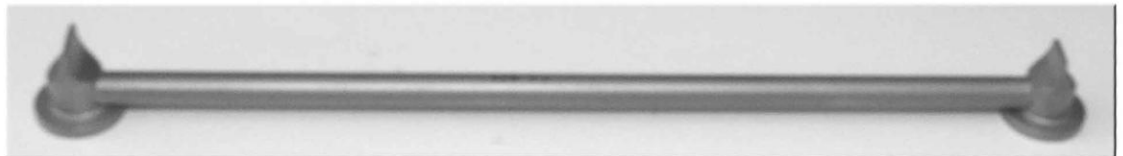

**DP 1782**  
DESCHIZATOR COROANE ( 2 CAPETE )  
KRONENABNEHMER ZWEISPITZIG  
CROWN REMOVER DOUBLE ENDED 22.50 €

*Preturile sunt exprimate in Euro si nu includ TVA*

52.



**DF 1760**  
**TAVITA RENALA MARE** 20 cm  
NIERENSCHALE  
KIDNEY DISHES 12.50 €



**DF 1761 /...**

**TAVITA INSTRUMENTAR** 1 (19 X 10 X 1,5 cm) 10.00 €  
**INSTRUMENT TABLETTEN** 2 (20 X 10 X 1 cm) 10.00 €  
**INSTRUMENT TRAYS** 3 (20 X 15 X 1 cm) 12.08 €

**DF 1762** **CUTIE INSTRUMENTAR CU GULER** 32X22X2 Cm  
INSTRUMENT TABLETTEN MIT RAND  
INSTRUMENT TRAY WITH COLLAR 20.42 €

**DF 1763** **CUTIE INSTRUMENTAR CU MARGINI PERFORATE** 29X18,5X1 cm  
INSTRUMENT TABLETTEN MIT PERFORIERT RAND  
INSTRUMENT TRAY PERFORATED EDGE 20.42 €



**CUTIE INSTRUMENTAR**  
INSTRUMENTEN BEHALTER  
INTRUMENTS BOXES

DF 066 (17x7x3 cm) 14.58 €  
DF 067 (17,5x7,5x3 cm) 15.42 €  
DF 068 (18x6x3 cm) 15.83 €  
DF 069 (18x7x3 cm) 16.25 €  
DF 070 (18x9x4 cm) 16.67 €  
DF 071 (20x10x4 cm) 18.33 €  
DF 072 (21x10x4 cm) 20.83 €  
DF 073 (25x12x5 cm) 33.33 €

**JG 1823**  
27 cm  
15.83 €

**JG 1825**  
27 cm  
16.67 €



**PENSA PENTRU**  
**INSTRUMENTAR STERIL**  
STERILISIERZANGE  
STERILIZING FORCEPS

*Preturile sunt exprimate in Euro si nu includ TVA*

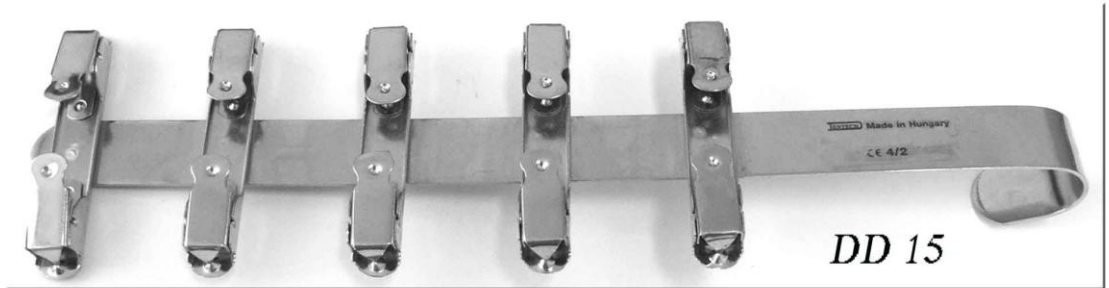

DD 15

SUPORT FILM RX  
FILMLEISTE  
X-RAY FILM HOLDER

20.83 €

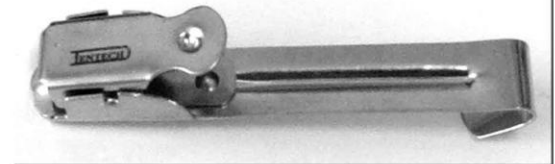

DD 16

SUPORT FILM RADIOGRAFIE  
RÖNTGENFILM PINZETTE  
X-RAY FILM CLIP

3.00 €



DD 17

SUPORT FILM TIP FERENCZI  
ZAHNFILMHALTER FERENCZI  
DENTAL FILM HOLDER FERENCZI

12.08 €

DF 1750



SUPORT VATA, METALIC  
WATTEBEHALTER, METALL  
COTTON WOOL HOLDER

14.17 €

LAMPA DE SPIRT  
SPIRITUSLAMPE  
ALCOHOL BURNER



DF 1751

14.17 €

Preturile sunt exprimate in Euro si nu includ TVA

54.

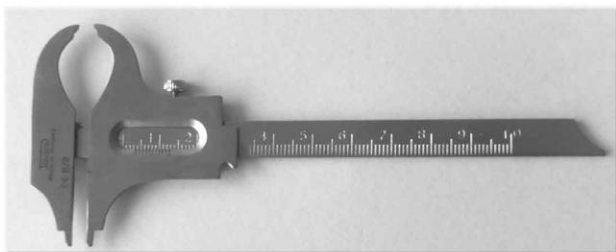

**MI 101**

INSTRUMENT PENTRU MASURAT GROSIMEA  
COROANELOR TIP BOLEY  
BOLEY SCHIEBLEHRE  
BOLEY BONE MEASURING INSTRUMENT

35.75 €

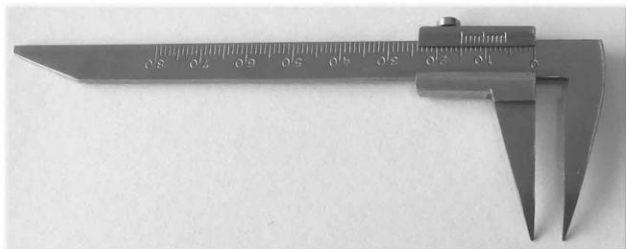

**MI 102**

INSTRUMENT PENTRU MASURAT GROSIMEA  
COROANELOR TIP BEERENDONK  
CSONTVASTAGSÁGMÉR  
BEERENDONK SCHIEBLEHRE  
BEERENDONK BONE MEASURING INSTRUMENT

35.42 €



**MI 103**

INSTRUMENT DE MASURAT GROSIMEA  
COROANELOR  
KNOCHEN MEBZIRKEL  
BONE MEASURING INSTRUMENT

38.96 €

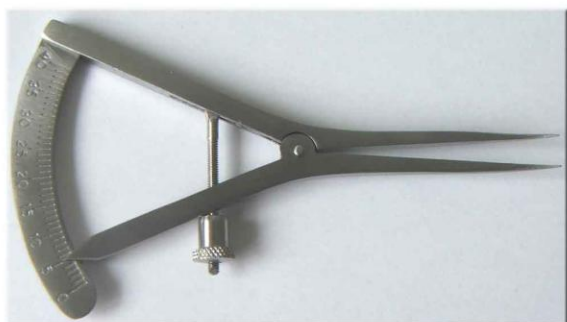

**MI 104**

INSTRUMENTE DE MASURAT GROSIMEA  
COROANELOR TIP CASTROVIEJO  
CASTROVIEJO KNOCHEN MEBZIRKEL  
CASTROVIEJO BONE MEASURING INSTRUMENT

37.50 €



**MI 105**

INSTRUMENT DE MASURAT GROSIMEA  
COROANELOR  
KNOCHEN MEBZIRKEL  
BONE MEASURING INSTRUMENT

40.00 €

*Preturile sunt exprimate in Euro si nu inlud TVA*

SET IMPLANTOLOGIE  
SET FÜR IMPLANTOLOGIE  
IMPLANTOLOGY SET

KI 100 66.67 €

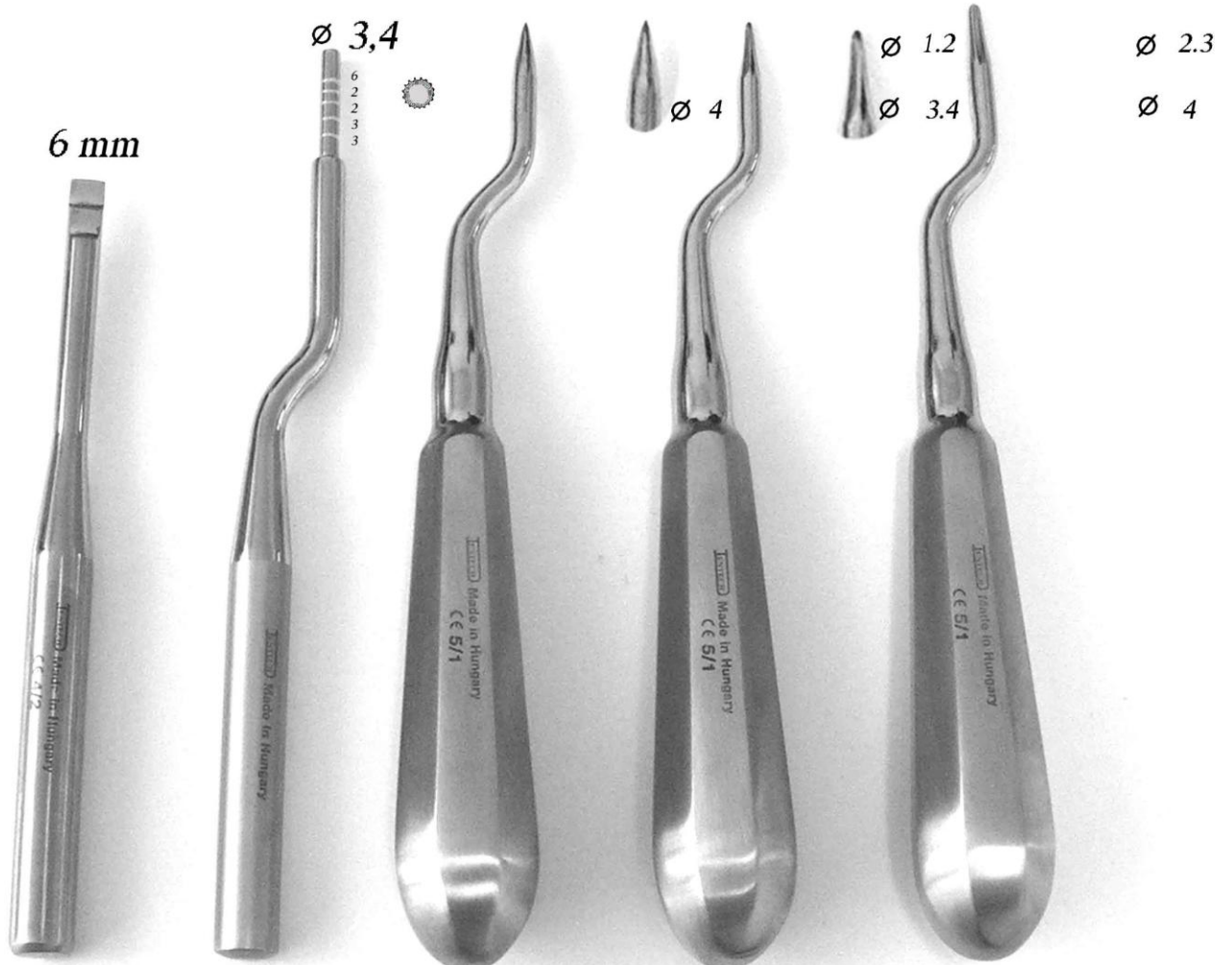

VI 101

BI 100

TI 100

TI 101

TI 102

DALTA OS CONCAVA  
CU MANER ROTUND

TREPAN  
SINUS

DILATATOR OS  
NETED

DILATATOR OS  
RIGUROS

DILATATOR OS  
RIGUROS

10.83 €

14.17 €

14.17 €

15.83 €

15.83 €

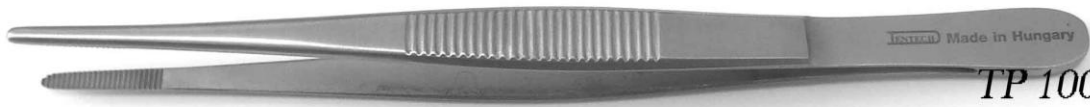

TP 100 18.75 €

PENSA ANATOMICA TITAN  
TITAN PINZETTE  
TITAN FORCEPS

DECOLATOR MUCOASA SINUSALA RI 100 4 mm  
SINUS RASPATORIUM  
SINUS RASPATORY 15.00 €

RI 101 6 mm



Preturile sunt exprimate in Euro si nu includ TVA

56.

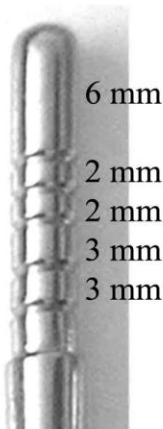

**OSTEOTOM**  
OSTEOTOM BAJONETT  
OSTEOTOM BAYONET

14.17 €

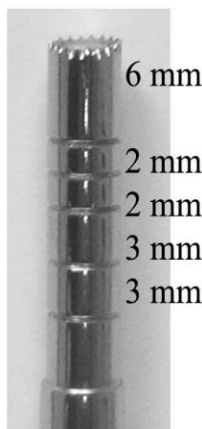

**SINOTOM**  
SINUTOM BAJONETT  
SINUTOME BAYONET

14.17 €



*Preturile sunt exprimate in Euro si nu includ TVA*



*SINOTOM CU OPRITOR  
SINUTOM MIT STOPPER  
SINUTOME WITH STOPPER*

*SB120 Ø 2 MM  
SB128 Ø 2,8 MM  
SB134 Ø 3,4 MM  
SB142 Ø 4,2 MM*

28.00 €

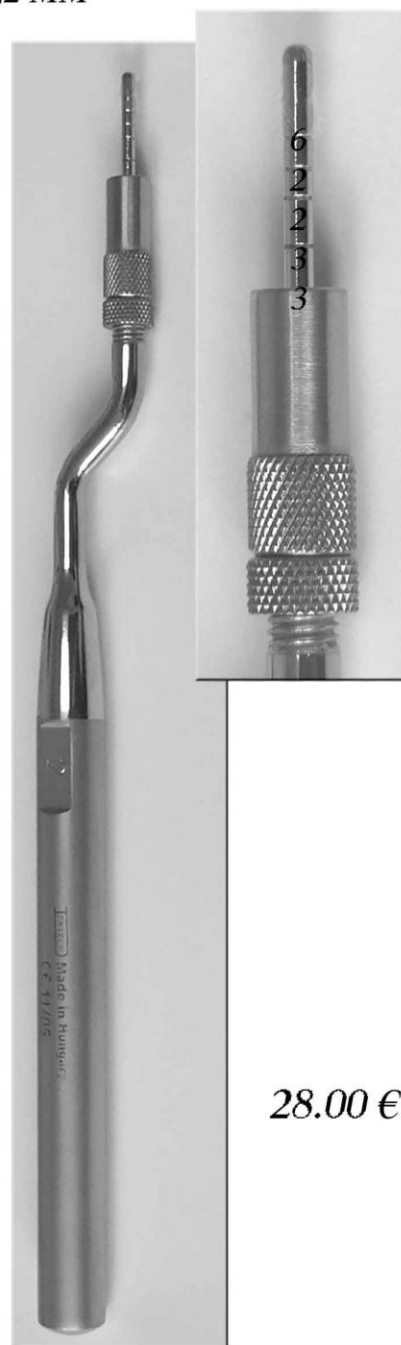

*OSTEOTOM CU OPRITOR  
OSTEOTOM MIT STOPPER  
OSTEOTOME WITH STOPPER*

*CT120 Ø 2 MM  
CT128 Ø 2,8 MM  
CT134 Ø 3,4,MM  
CT142 Ø 4,2 MM*

28.00 €

*Preturile sunt exprimate in Euro si nu includ TVA*

58.



CD1000  
MOARA DE OS  
KNOCHENMÜHLE  
BONE-MILL

90.00 €

*Preturile sunt exprimate in Euro si nu includ TVA*



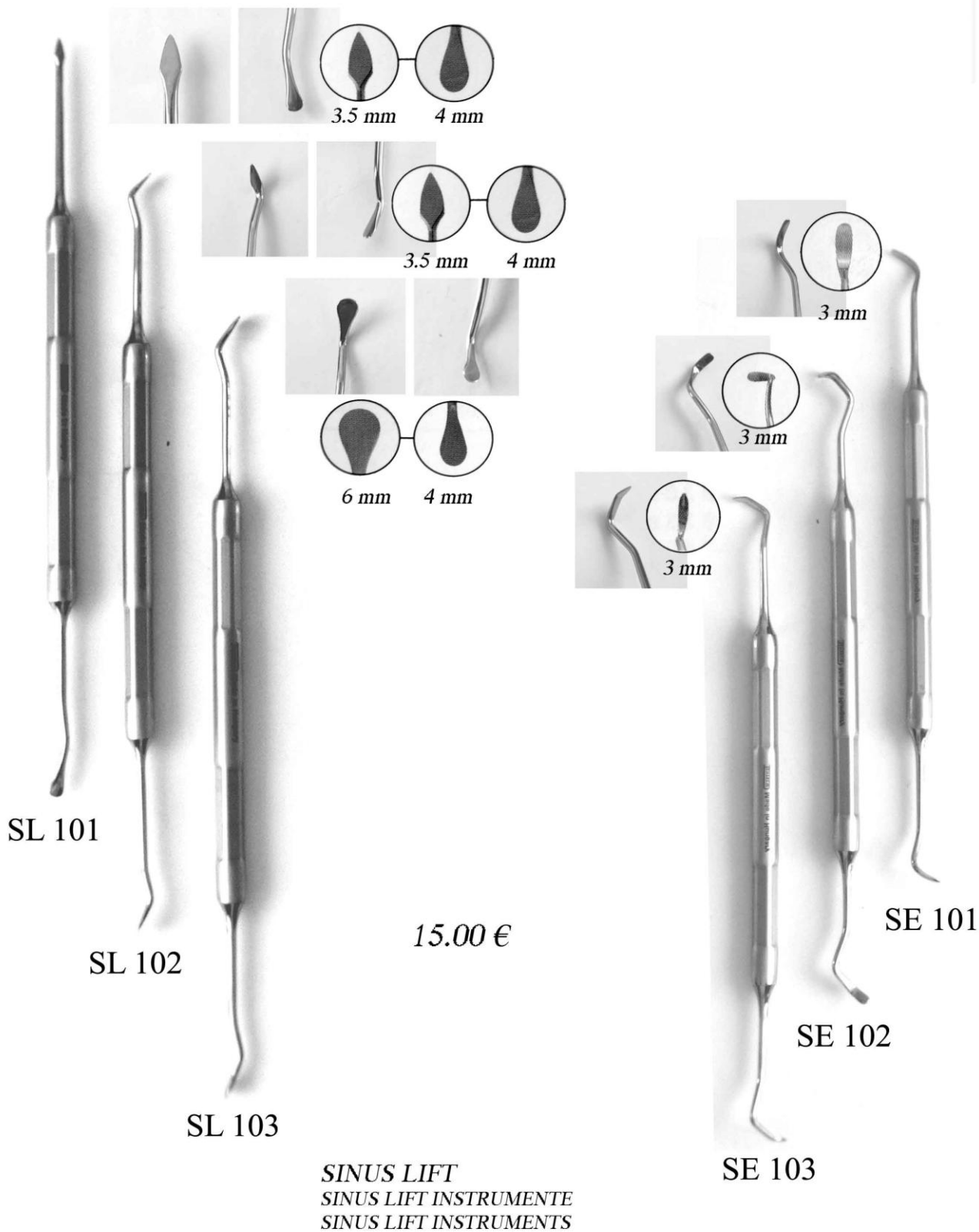

*Preturile sunt exprimate in Euro si nu includ TVA*

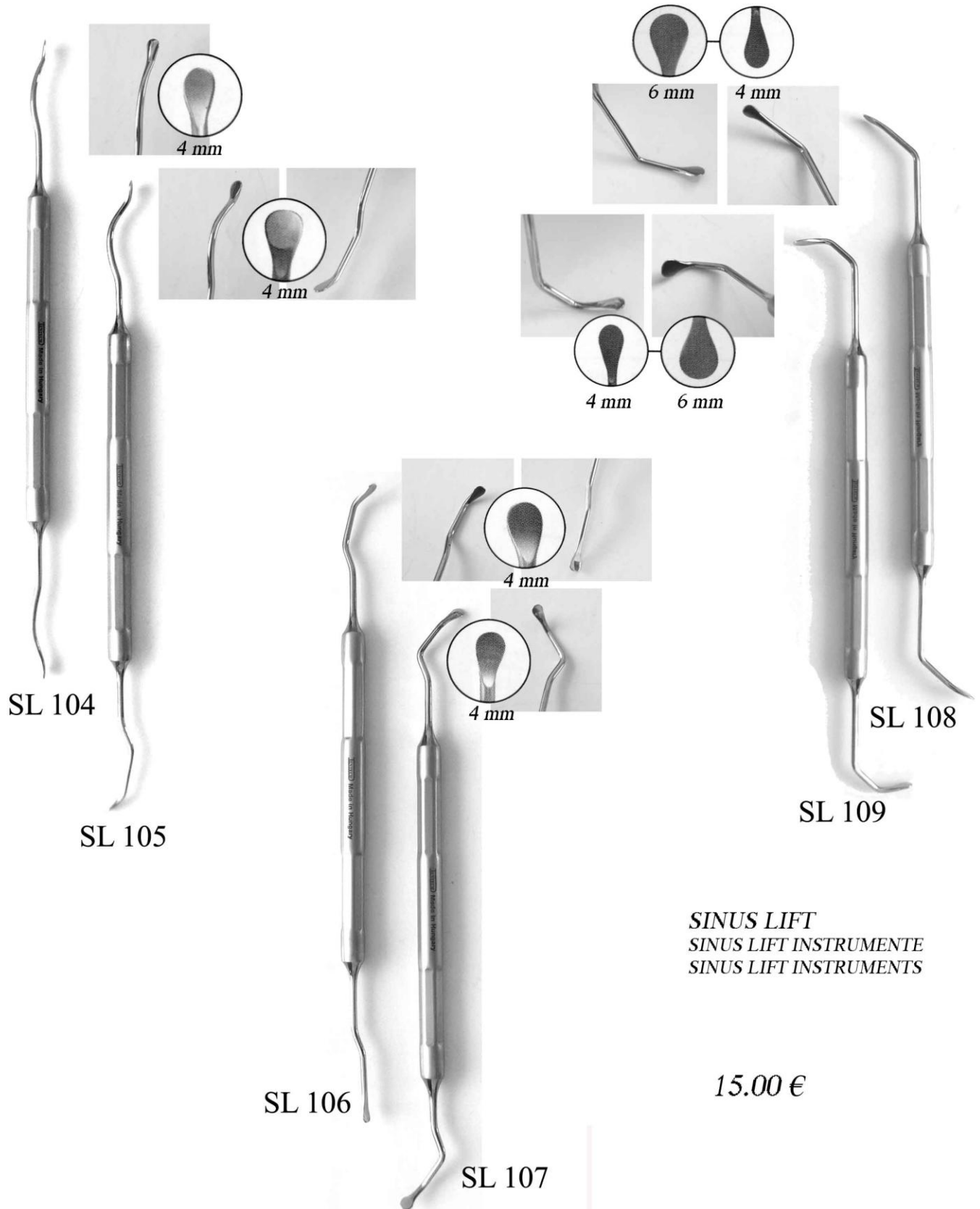

SL 104

SL 105

SL 106

SL 107

SL 108

SL 109

**SINUS LIFT**  
SINUS LIFT INSTRUMENTE  
SINUS LIFT INSTRUMENTS

15.00 €

*Preturile sunt exprimate in Euro si nu includ TVA*

**CIUPITOARE OS - 14 cm**

**HOHLMEISSELZANGE -**

**BONE RONGUER FORCEPS**



**FO 1409**  
41.00 €



**FO 1415**  
41.00 €



**FO 1412**  
41.00 €



**FO 1416**  
41.00 €



**FO 1656**  
41.00 €

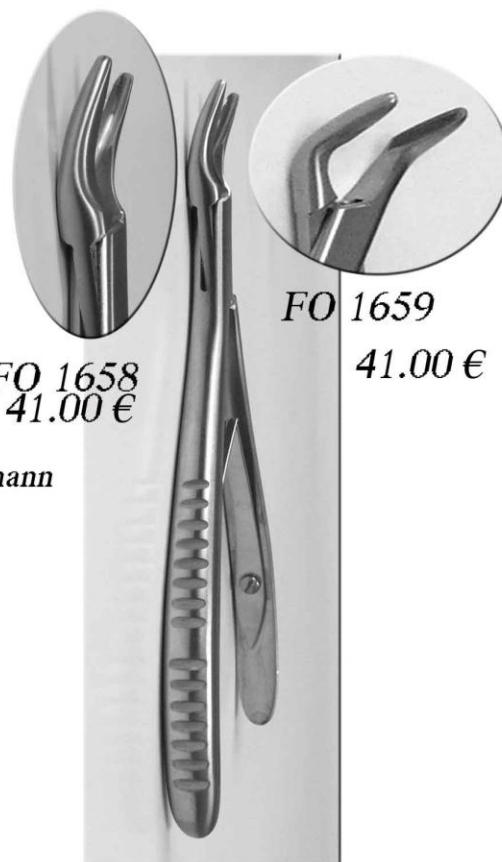

**FO 1658**  
41.00 €

**FO 1659**  
41.00 €

*Micro Friedmann*

*Preturile sunt exprimate in Euro si nu includ TVA*

62.



**DP 2000**  
**CLESTE KOFFERDAMM**  
**KOFFERDAMM ZANGE**  
**CLAMP FORCEPS**

28.33 €

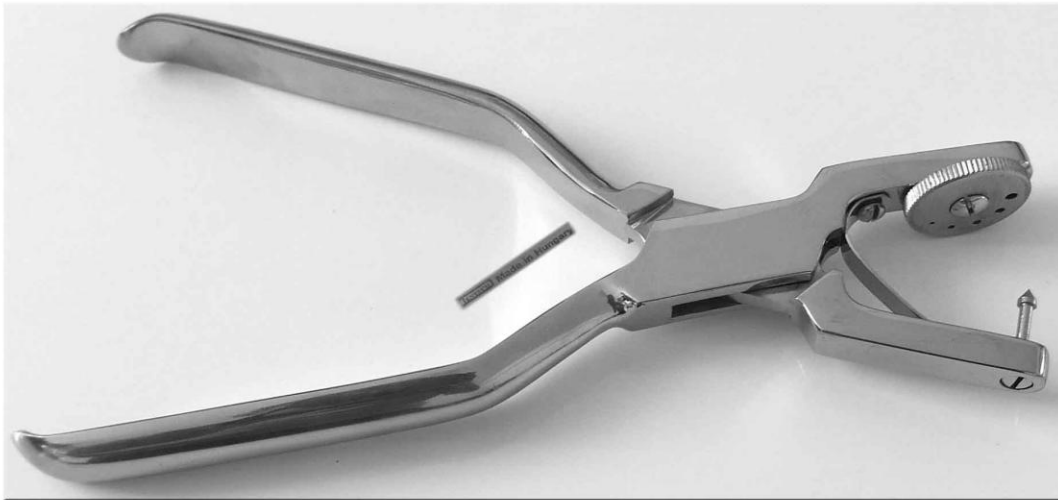

**DP 2100**  
**CLESTE KOFFERDAMM APLICATOR INELE PENTRU MATRICI**  
**KOFFERDAMM LOCHZANGE**  
**RUBBER DAM PUNCH**

36.75 €

*Preturile sunt exprimate in Euro si nu includ TVA*



**DK 2100**  
**CLAMA KOFFERDAMM**  
KOFFERDAMM KLAMMERN  
RUBBERDAM CLAMP 6.25 €

**DR 2100**  
**RAMA KOFFERDAMM** 6.67 €  
KOFFERDAMM RAHMEN  
RUBBERDAM FRAME



FRONT-ANTERIOR



VÉKONY FOGHOZ  
MIT DÜNNEM ZAHNHALS  
FOR THIN THEETH

PREMOLARI-PRAMOLAR-PREMOLAR



FELSŐ  
STANDARKLAMMER  
FÜR OBERE PRAMOLAREN  
STANDARDCLAMP FOR  
UPPER PREMOLARS



ALSÓ  
STANDARKLAMMER  
FÜR UNTERE PRAMOLAREN  
STANDARDCLAMP FOR  
LOWER PREMOLARS



ALSÓ-FELSŐ  
FÜR OBERE UND UNTERE  
PRAMOLAREN  
FOR UPPER AND LOWER  
PREMOLARS

MOLARI-MOLAR-MOLARE



ALSÓ  
STANDARKLAMMER  
FÜR UNTERE MOLAREN  
STANDARDCLAMP  
FOR LOWER MOLARS



FELSŐ  
STANDARKLAMMER  
FÜR OBERE MOLAREN  
STANDARDCLAMP  
FOR UPPER MOLARS



GYÖKÉR ALSÓ-FELSŐ  
WURZELKLAMMER FÜR OBERE  
UND UNTERE MOLAREN  
ROOTCLAMP FOR UPPER  
AND LOWER MOLARS



FERDE FOGAKHOZ  
FÜR SCHRAGSTEHENDE  
MOLAREN  
FOR OBLIQUE THEETH

Preturile sunt exprimate in Euro si nu includ TVA

64.



**OD 200**

**APLICATOR-INDEPARTATOR INELE  
DE CAUCIUC  
REINIGER  
SCALER**

**9.17 €**



**OD 1756**

**APLICATOR INELE DE CAUCIUC  
BANDAUFSETZER  
BAND PUSHER**

**15.00 €**



**OD 202 17 cm**

**STOKE**

**CLESTE APLICATOR INELE DE CAUCIUC  
SEPARIERZANGE ZUM SPREIZEN DER  
DENTALASTIC-SEPARIERRINGE VOR DEM POSITIONIEREN  
SEPARATING PLIERS FOR EXPANDING DENTALASTICS  
BEFORE POSITIONING**

**44.17 €**

*Preturile sunt exprimate in Euro si nu includ TVA*

PORTACE- NADELHALTER - NEEDLE HOLDERS

TC

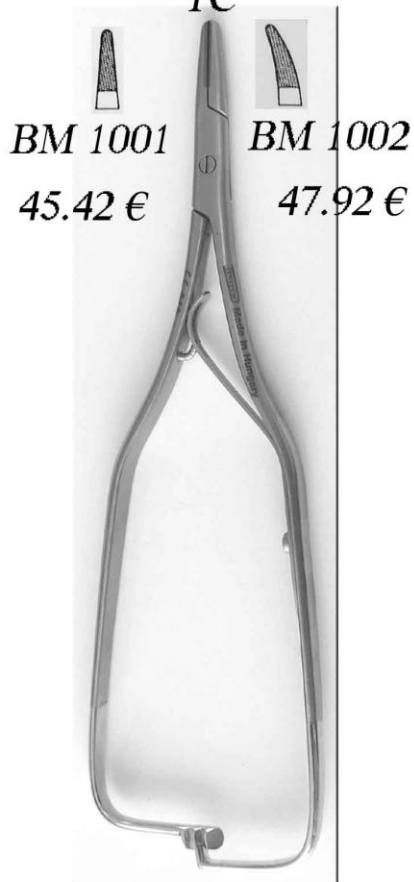

BM 1001

45.42 €

BM 1002

47.92 €

ARRUGA  
16 cm



BM 1000 14 CM

BACHMANN

49.17 €



OD 1000 PENZA BRACKET

BRACKET-PINZETTE

BRACKET PLACING TWEEZERS

13.33 €



14 cm

OD 1307

35.83 €

CLESTE PENTRU  
INDREPTAT BRACKET  
BRACKET-ABNEHME ZANGE  
BRACKET REMOVING PLIERS

Preturile sunt exprimate in Euro si nu includ TVA

66.

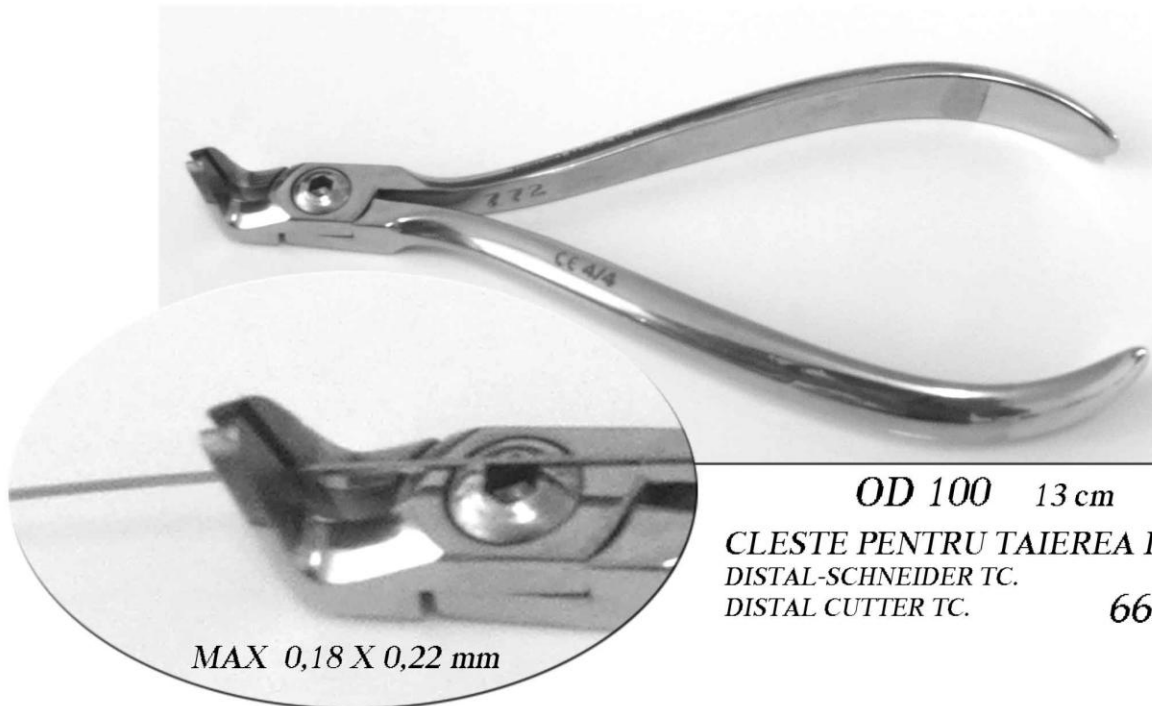

OD 100 13 cm

CLESTE PENTRU TAIEREA DISTALA  
DISTAL-SCHNEIDER TC.  
DISTAL CUTTER TC. 66.25 €

MAX 0,18 X 0,22 mm



OD 101 13 cm

CLESTE PENTRU TAIERE LIGATURI  
LIGATURENSCHNEIDER TC.  
LIGATURE CUTTING PLIERS TC. 45.42 €

MAX 0,7 mm

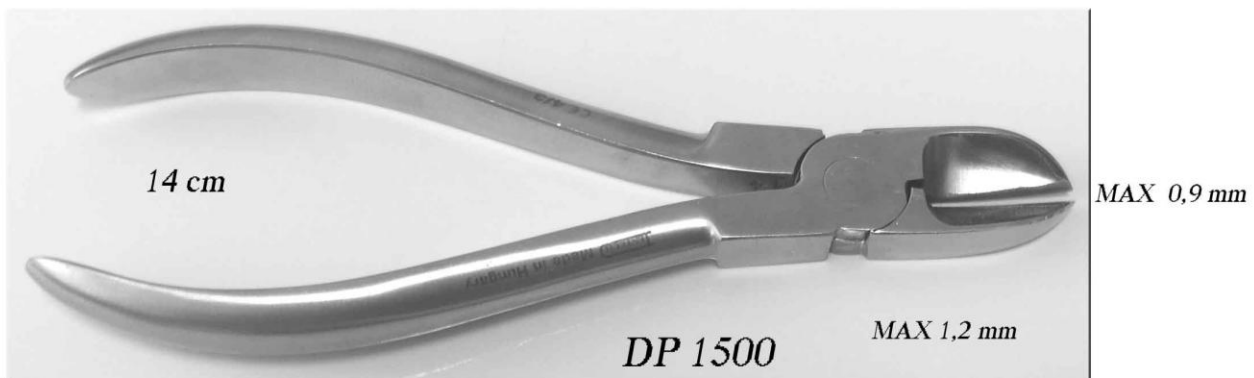

14 cm

DP 1500

MAX 1,2 mm

MAX 0,9 mm

CLESTE PENTRU SARMA  
DRAHTSCHNEIDEZANGEN  
WIRE CUTTERS

35.00 €

Preturile sunt exprimate in Euro si nu includ TVA



**CLESTI LIGATURI**  
LIGATUREN ZANGE  
LIGATURE FORCEPS



OD 201

ADAPTOR LIGATURI  
LIGATURENADAPTER  
LIGATURE TUCKER

7.08 €

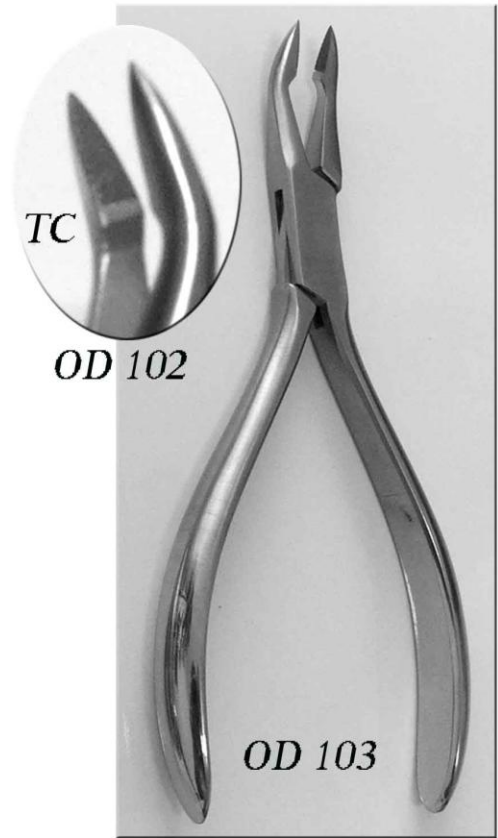

TC

OD 102

OD 103

WEINGART 14 cm

33.33 €



DP 1390

HOW 14 cm 33.33 €



DP 1393

HOW 14 cm 34.17 €

*Preturile sunt exprimate in Euro si nu includ TVA*

**CLESTE CRAMPON TELESCOPIC -**

TELESKOP KRONEN ZANGE -

TELESCOPE CROW PLIERS

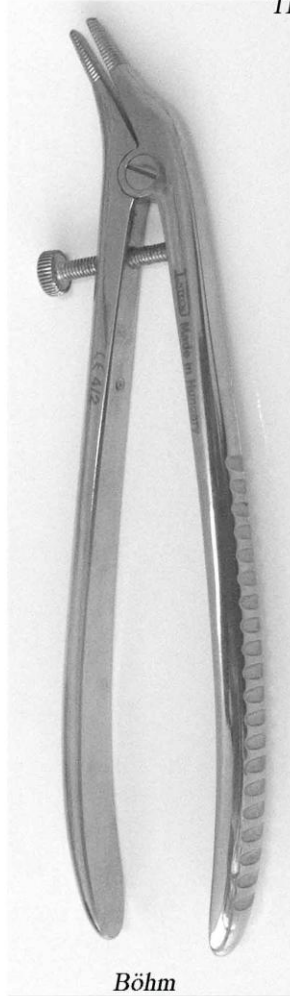

Böhm  
15 cm / 6"

**CLESTE TEHNIC**

TECHNIK ZANGE

TECHNICAL PLIERS

MAX 0,9 mm



MAX 0,7 mm

DP 1505 15 cm

**CLESTE CRAMPON**  
UNIVERSAL-KRAMPONZANGE  
UNIVERSAL TECHNICAL PLIERS

32.92 €

BÖHM	a	b	c	d
<b>DP 1739</b>	3,3	4,0	2,3	3,0mm
<b>DP 1740</b>	4,4	5,0	3,4	3,8mm

32.92 €

32.92 €

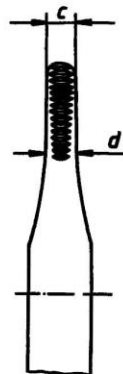
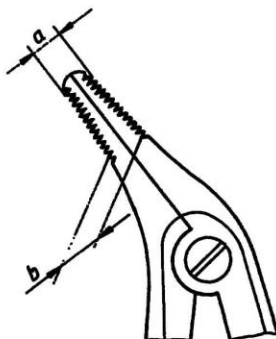

**CLESTE CRAMPON**

KARAMPON ZANGE

UNIVERSAL

TECHNICAL PLIERS

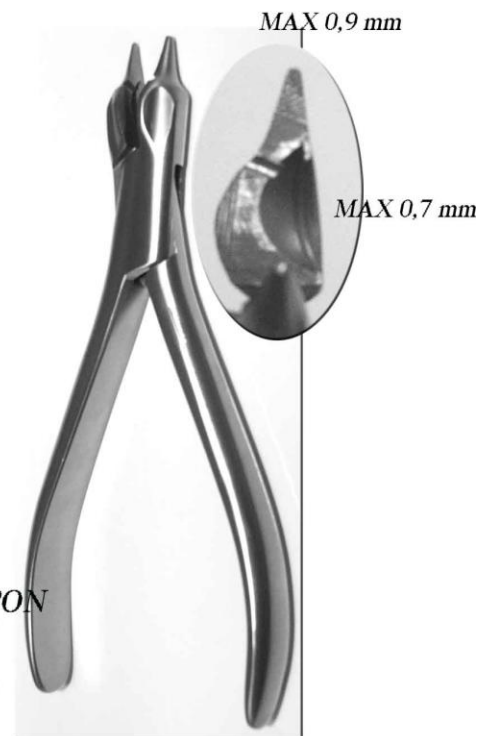

MAX 0,9 mm

MAX 0,7 mm

DP 1501 15 cm

32.92 €

Preturile sunt exprimate in Euro si nu includ TVA

**CLESTI ARCUIRE**  
**DRAHTBIEGEZANGEN**  
**WIRE BENDING PLIERS**

**MAX 0.7 mm**



**DP 1122** 14 cm  
**LANGENBECK**  
32.92 €



**DP 1315** 13 cm  
**ADERER**  
32.92 €



**DP 1316** 13 cm  
**ADERER**  
32.92 €



**DP 1312** 13 cm  
**ADAMS**  
32.92 €

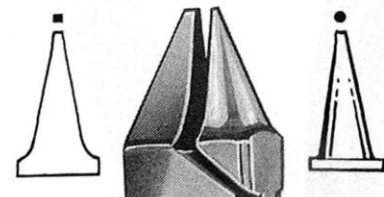

**DP 1310** 13 cm  
**ANGLE**  
32.92 €

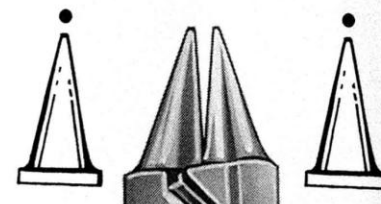

**DP 1311** 13 cm  
**ANGLE**  
32.92 €

*Preturile sunt exprimate in Euro si nu includ TVA*

70.

CLESTI ARCUIRE PLATE - FLACHZANGEN - FLAT NOSE PLIERS



14 cm



DP 11  
28.75 €



DP 12  
28.75 €



DP 111  
28.75 €



DP 122  
28.75 €



DP 135  
28.75 €



DP 132  
28.75 €

CLESTI ARCUIRE - DRAHTBIEGEZANGEN - WIRE BENDING PLIERS



DP 1141

Mc KELLOPS

16 cm  
max 1,5 mm  
32.92 €



14 cm



DP 1133 32.92 €

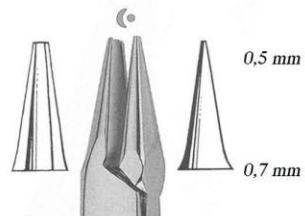

DP 1134 32.92 €  
SCHWARTZ

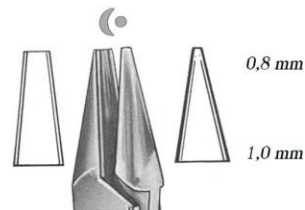

DP 1135 32.92 €  
FISCHER

Preturile sunt exprimate in Euro si nu includ TVA

CLESTI ARCUIRE



DP 1301  
TWEED  
32.92 €

DRAHTBIEGEZANGEN

WIRE BENDING PLIERS



DP 1355  
ADERER  
32.92 €



DP 1324  
De La Rosa  
32.92 €

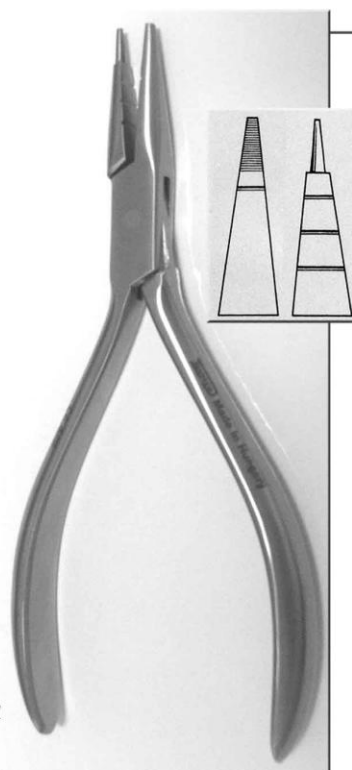

DP 1308  
JARABAK



DP 1323  
YOUNG  
32.92 €

Preturile sunt exprimate in Euro si nu includ TVA



**CLESTE CU TREPTE**  
SCHLAUFENBIEGEZANGE  
LOOP FORMING PLIERS

**OD 1327**  
NANCE  
35.83 €

**CLESTE PENTRU CURBURI**  
BOGENFORMZANGEN  
ARCH FORMING PLIERS



13 cm  
**OD 1317**  
TWEED  
35.00 €

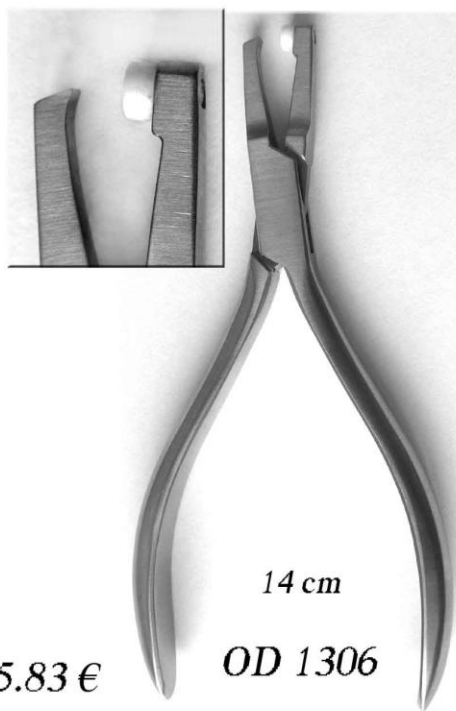

35.83 €

**OD 1306**

**CLESTE PENTRU INDEPARTAREA CAUCIUCULUI**  
BAND-ABNEHME ZANGE MIT TEFLON EINZATZ  
BAND REMOVING PLIERS WITH TEFLON INSERT

max 1,0 mm

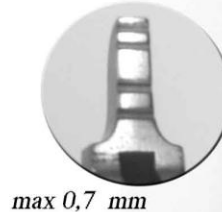

max 0,7 mm

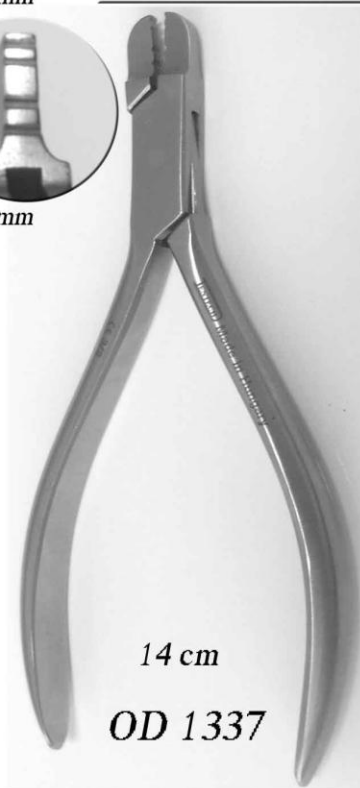

14 cm  
**OD 1337**

36.67 €

**CLESTE PENTRU BUCLE**  
BÜGELBIEGEZANGE  
LINGUAL ARCH BENDING PLIERS

*Preturile sunt exprimate in Euro si nu includ TVA*

INSTRUMENTAR DE MODELAJ -

MODELLIER INSTRUMENTE

MODELLING INSTRUMENTS

4.17 €

DS 1301

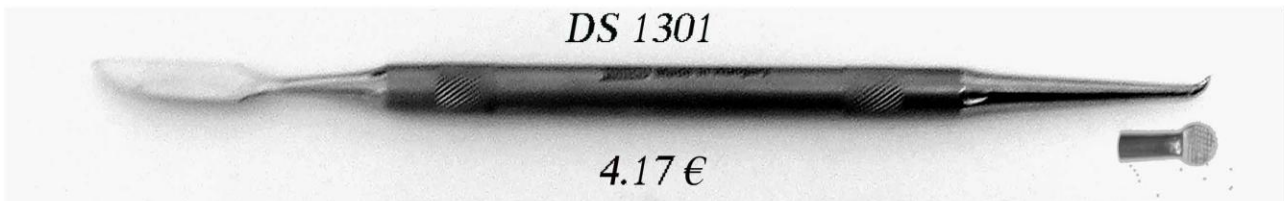

4.17 €

DS 1302

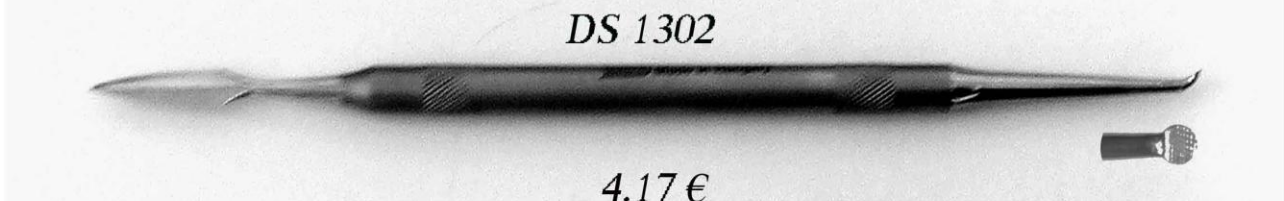

4.17 €

DS 1303

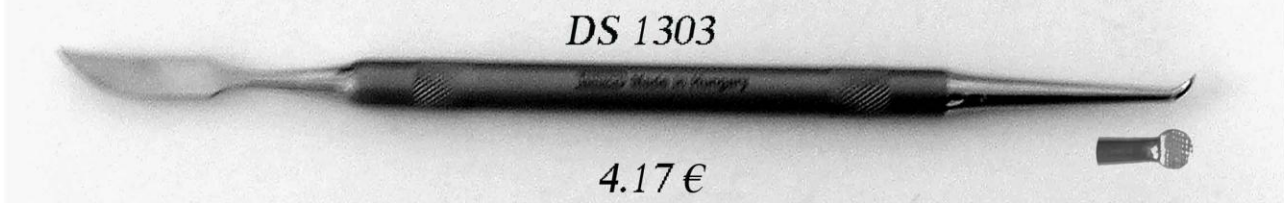

4.17 €

DS1304

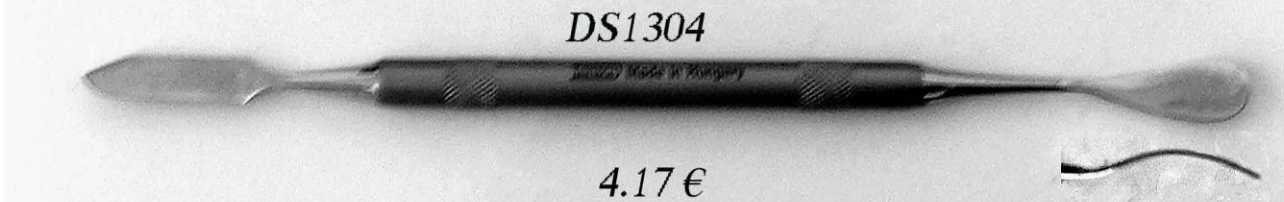

4.17 €

DS 1305

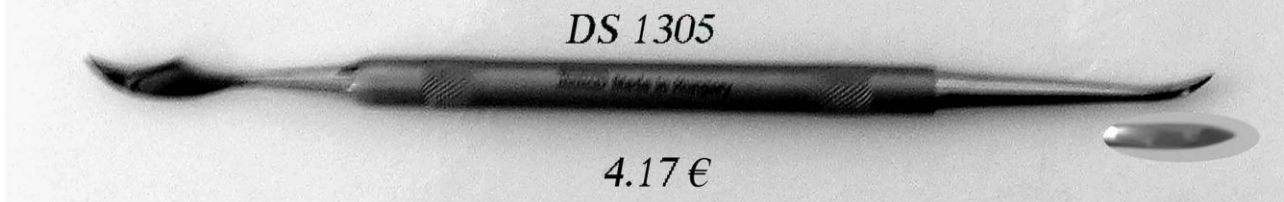

4.17 €

DS 1306

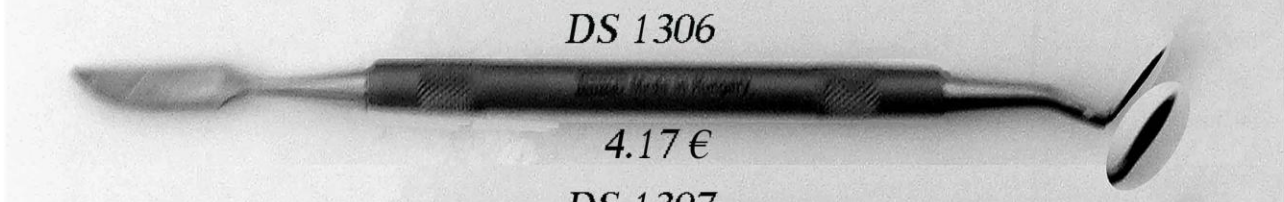

4.17 €

DS 1307

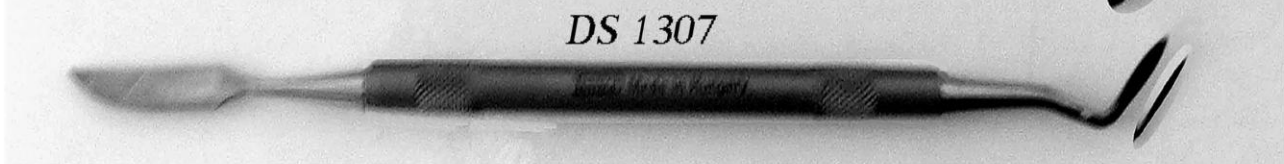

Preturile sunt exprimate in Euro si nu includ TVA

74.

INSTRUMENTAR MODELAJ -

MODELLIER INSTRUMENTE

MODELLING INSTRUMENTS

4.17 €



DS 1308

4.17 €



DS 1309

4.17 €



DS 1310

4.17 €



DS 1311

4.17 €

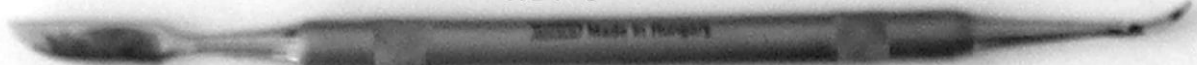

DS 1312

4.17 €



DS 1313

4.17 €



DS 1314

*Preturile sunt exprimate in Euro si nu includ TVA*



APLICATOARE - AKRYLATE INSTRUMENTE - ACRYLATE MODELLING INSTRUMENTS

DS 1401 4.17 €



DS 1402



DS 1403 4.17 €

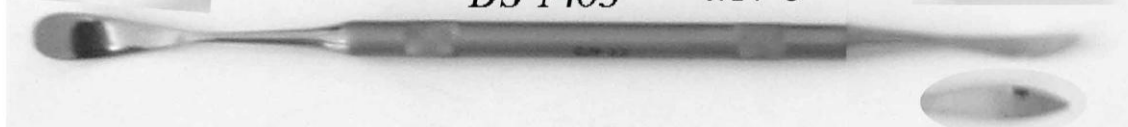

INSTRUMENT P.K. THOMAS  
MODELLIERINSTRUMENTE  
P. K. THOMAS INSTRUMENTS

DS 1241 3.75 €



DS 1242 3.75 €

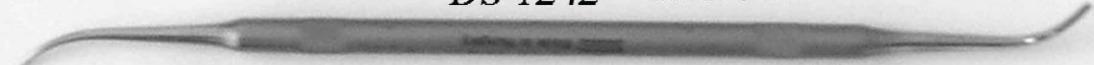

DS 1243 3.75 €



DS 1244 4.17 €



DS 1245 4.17 €



INSTRUMENTE DE GRAVAT - GRAVIERER - ENGRAVER

DS 1405 2.92 €



DS 1404 2.08 €



*Preturile sunt exprimate in Euro si nu includ TVA*

76.

**CUTIT SEPARATOR CERAMICA**  
SEPARIERMESSER AUS KERAMIK  
SEPARATE KNIFE FOR CERAMICS

**DS 100**



0,1 mm

2.92 €

**DS 101**

**TIP/ TYP/ TYPE FIG.11**



**DS 1353**

**PORTLAMA BISTURIU ROTUNDA**  
CU INCHIZATOR  
PATRONENSPANNER  
CARTRIDGE CLAMP

**DS 1350**

4.58 €



**VARF MODELAJ**  
EINSATZSPIZ FÜR  
GRAVIERINSTRUMENTE  
TIP FOR CATRIDGE CLAMP

0.42 €

**CLESTE SUPTOR PENTRU COROANE CERAMICE**  
KRONENHALTEKLEMMEN  
CROWN HOLDING CLAMPS



**DS 103**



**DS 102**

14.17 € 12.5 cm 13.33 €

*Preturile sunt exprimate in Euro si nu includ TVA*

**SPATULA GIPS**  
SPATELN FÜR ALGINAT UND GIPS  
ALGINAT AND PLASTER SPATULAS

5.42 €



DS 115 DS 118

**CUTIT GIPS**  
GIPSMESSER  
PLASTER KNIFE

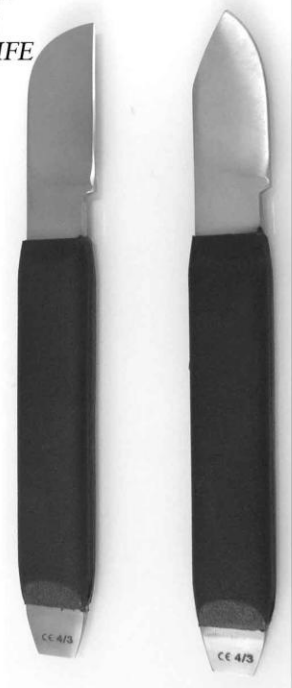

DS 160 DS 161

6.41 €



DS 120

**SPATULA GIPS**  
GIPSSPATELN  
PLASTER SPATULAS

3.21 €

**CUTIT MODELAT**  
CEARA  
WACHSMESSER  
WAX KNIVES



DS 1101  
4.58 €

DS 1102  
5.21 €

DS 1103  
5.00 €

DS 1104  
5.83 €

*Preturile sunt exprimate in Euro si nu includ TVA*

78.

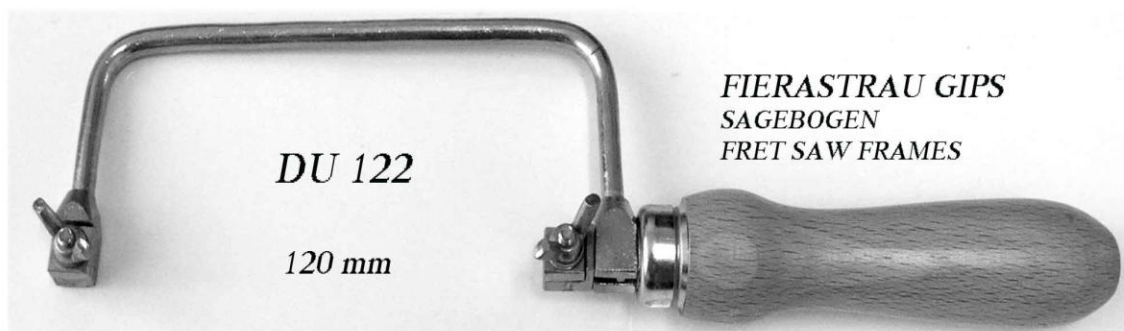

10.00 €



7.50 €



20.83 €

*Preturile sunt exprimate in Euro si nu includ TVA*



DU 153

CLESTE FOITA  
ADAPTA ZANGE  
FOIL HOLDER

11.67 €

INELE DE CHIUVETA  
KÜVETTENBÜGEL  
FLASK CLAMP

30.83 € DS 1706

28.33 € DS 1705

25.83 €  
DS 1704

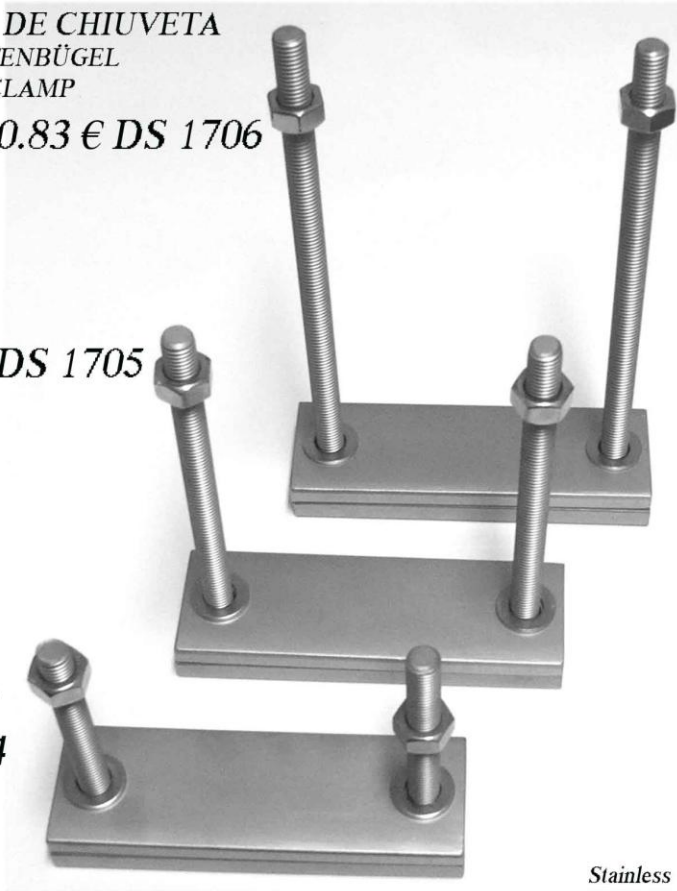

Stainless

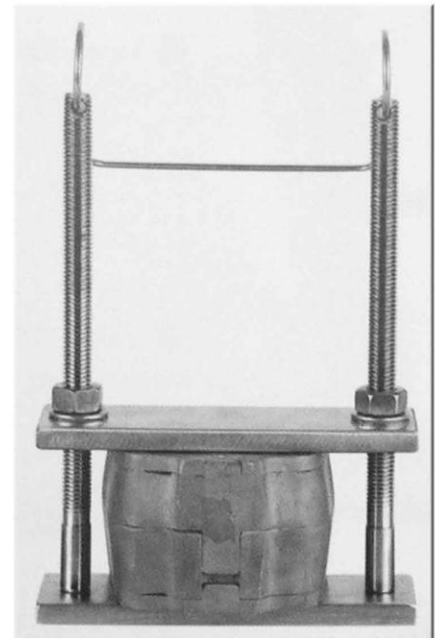

CLESTE DE TURNAT PENTRU CHIUVETA  
TIEGEL ZANGE  
MOULD TONGS

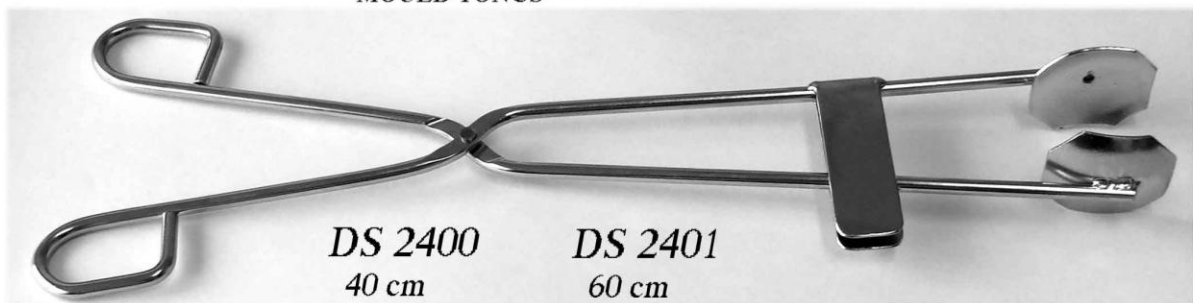

DS 2400  
40 cm

DS 2401  
60 cm

20.42 €

24.58 €

Preturile sunt exprimate in Euro si nu includ TVA

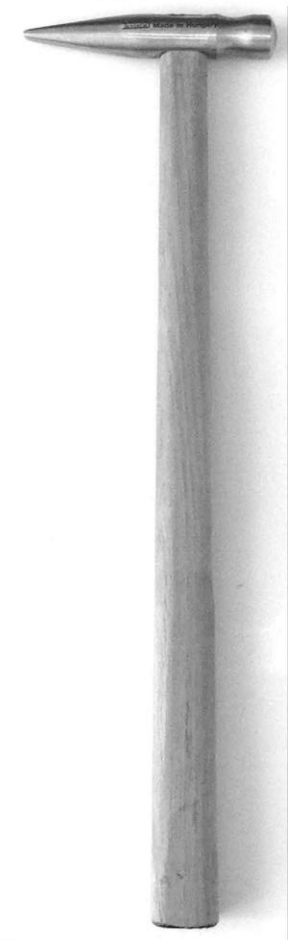
**CHIUVAT PENTRU TURNAT- MUFFELRINGE - CASTING RINGS**
**DU 151**

**CIOCAN TEHNIC**  
**HAMMER FÜR ZAHNTECHNIK**  
**TECHNICAL MALLETS**

**4.13 €**

Ø 30 x 2 x 55

**DS 2501****2.75 €**

Ø 48.3 x 2 x 55

**DS 2503****3.66 €**

Ø 63.5 x 2 x 55

**DS 2506****3.96 €**

Ø 80 x 2 x 55

**DS 2509****5.04 €****DS 2500**

**SUPORT CAUCIUC PENTRU AMBALARE**  
**MUFFEL BÖDEN**  
**MOULD BASE SOCKET**

**4.59 €**

*Preturile sunt exprimate in Euro si nu includ TVA*

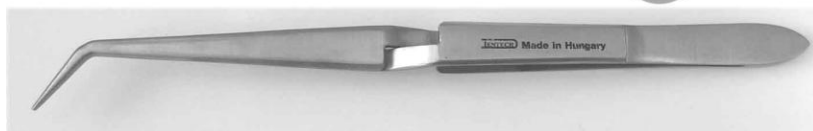

**DS 2780**

**PENSA PENTRU LIPIATURA**  
**LÖTPINZETTEN**  
**SOLDERING TWEEZERS**

**10.00 €**

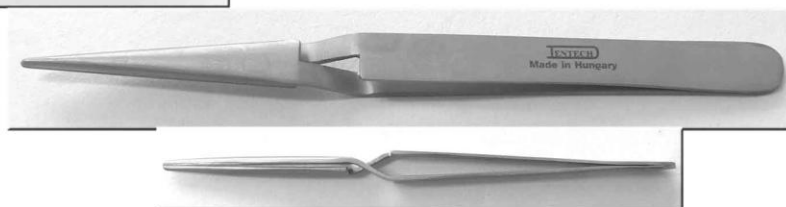

**DS 2781**

**10.00 €**



**DS 2405**

**10.00 €**

**INSTRUMENT PENTRU MASURAT GROSIMEA COROANELOR**  
**MESSZIRKEL IWANSON**  
**CALIPER IWANSON**



**DS 2404**  
**17.00 €**

**CHIUVETA PENTRU MODELAT**  
**DUPLICAT ALUMINIU**  
**DUBLIR KÜVETTE**  
**DUPLICATING FLASK**



**DS 3404**  
**17.00 €**

*Preturile sunt exprimate in Euro si nu includ TVA*

FOARFECI COROANE - KRONENSCHERE - CROWN SCISSORS



DP 1561  
14.21 €



DP 1562  
14.21 €



DP 1563  
14.21 €



DP 1551

UNIVERSAL  
12.5 cm / 5"

17.88 €



DP 1560

BEEBEE  
13.29 €

Preturile sunt exprimate in Euro si nu includ TVA



LINGURI DE AMPRENTE, METAL  
ABDRUCKLÖFFEL AUS METALL  
IMPRESSION TRAY  
STAINLESS STEEL



superior  
oberer  
upper

inferior  
unterer  
lower

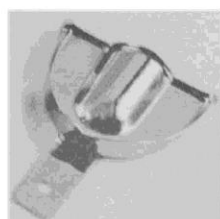

superior  
oberer  
upper

inferior  
unterer  
lower

UT 2645 XL  
UT 2646 L  
UT 2647 M  
UT 2648 S  
UT 2649 XS

LT 2650 XL  
LT 2651 L  
LT 2652 M  
LT 2653 S  
LT 2654 XS

5.83 €

5.83 €

UT 2635 XL  
UT 2636 L  
UT 2637 M  
UT 2638 S  
UT 2639 XS

LT 2640 XL  
LT 2641 L  
LT 2642 M  
LT 2643 S  
LT 2644 XS

5.83 €

5.83 €

*Preturile sunt exprimate in Euro si nu includ TVA*

84.

**PLACA STICLA PENTRU MALAXAT - ZEMENT MISCHPLATTE AUS GLAS -  
CEMENT MIXER PLATE GLASS**



**DF 1120**  
100 X 100

2.26 €



**DF 1121**  
130 X 80

2.26 €



**DD 14**  
40 cm

**PENSA BABETICA  
SERVIETTENHALTER  
NAPKIN HOLDER**

3.33 €

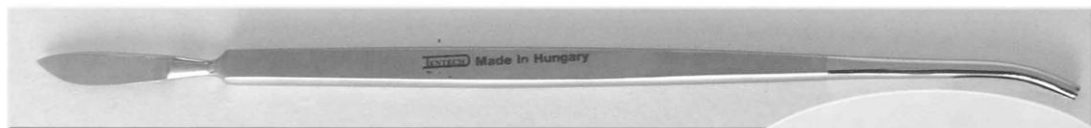

**DL 101**  
**TAIETOR AMPRENTA**  
ABDRUCKSCHNEIDER  
IMPRESSION CUTTER



**DL 100**  
**TAIETOR AMPRENTA**  
ABDRUCKSCHNEIDER  
IMPRESSION CUTTER 13.33 €

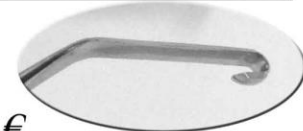

3 x 6

Ø 3

**ASPIRATOARE CHIRURGICALE**  
SPEICHELSAUGER FÜR STOMATOLOGIE, METALL  
SUCTION TUBE FOR STOMATOLOGY, STAINLESS STEEL

210 mm  
6.67 € DD 19

210 mm  
6.67 € DD 13

210 mm  
6.67 € DD 18



Ø 6

**DD 12**

**ASPIRATOR SALIVA**  
SAUGENKANÜLE, METALL  
SUCTION TUBE

5.00 €

*Preturile sunt exprimate in Euro si nu includ TVA*



**DZ 853**  
28 x 18 x 3 cm  
CUTIE INSTRUMENTE 20 PIESE  
INSTRUMENTEN BEHALTER  
FÜR 20 STK.  
INTRUMENTS BOXES FOR 20 PCS

41.25 €

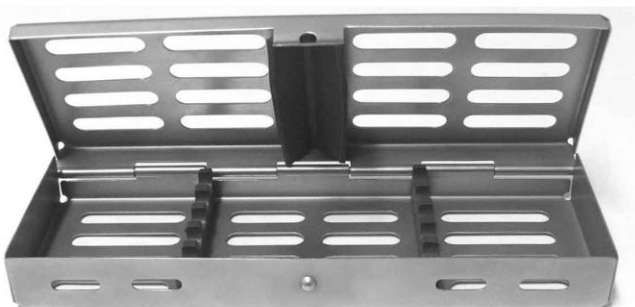

**DZ 851**  
18 X 7 X 2.5 cm  
CUTIE INSTRUMENTE 5 PIESE  
INSTRUMENTEN BEHALTER  
FÜR 5 STK.  
INTRUMENTS BOXES FOR 5 PCS

25.00 €

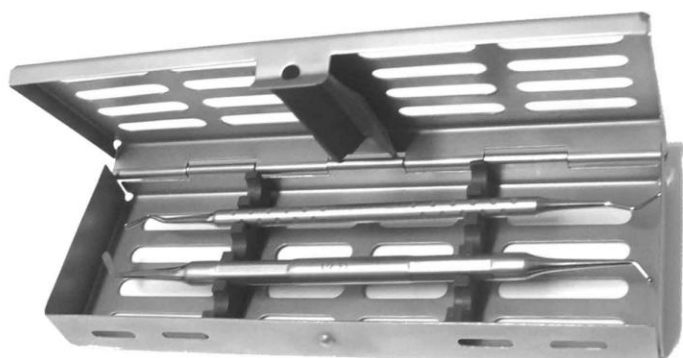

**DZ 852**  
18 x 14 x 2.5 cm  
CUTIE INSTRUMENTE 10 PIESE  
INSTRUMENTEN BEHALTER  
FÜR 10 STK.  
INTRUMENTS BOXES FOR 10 PCS

35.42 €

*Preturile sunt exprimate in Euro si nu includ TVA*