



Cefla s.c. - Via Selice Provinciale 23/a, 40026 Imola - Italy
Tel. +39 045 8202727 - 045 583500
info@newtom.it www.newtom.it

Cone Beam 3D Imaging
NewTom
what's next



THE DNA OF A LEADER.

Latest-generation technology

Ultra-fast scanning

Patented innovations

Broad range of available programmes

Maximum image quality

Versatile, user-friendly NNT software

Accurate treatment-planning

Outstanding patient comfort



New, heightened 2D application potential

NewTom GO has evolved out of 20 years experience and engineering know-how gained with NewTom, the brand that pioneered the use of Cone Beam technology in dentistry.

This exceptional product is designed for dentists who want to enhance dental surgeries with guaranteed quality equipment that provides excellence, technological innovation and unquestionable performance.

THE MASTERMIND OF CBCT IMAGING

GO

High quality diagnosis

Self-adaptive focusing and filters deliver always-perfect diagnostic results.

Patient health

The ECO-PAN protocol and SafeBeam™ technology reduce exposure times and eliminate the risk of over-estimated dosage.

Immediate diagnosis

Accurate, patient-guided positioning and ultra-fast scanning are yours at the touch of a button.

Quick installation

Simple, fast, intelligent installation ensures NewTom GO is ready to go immediately.

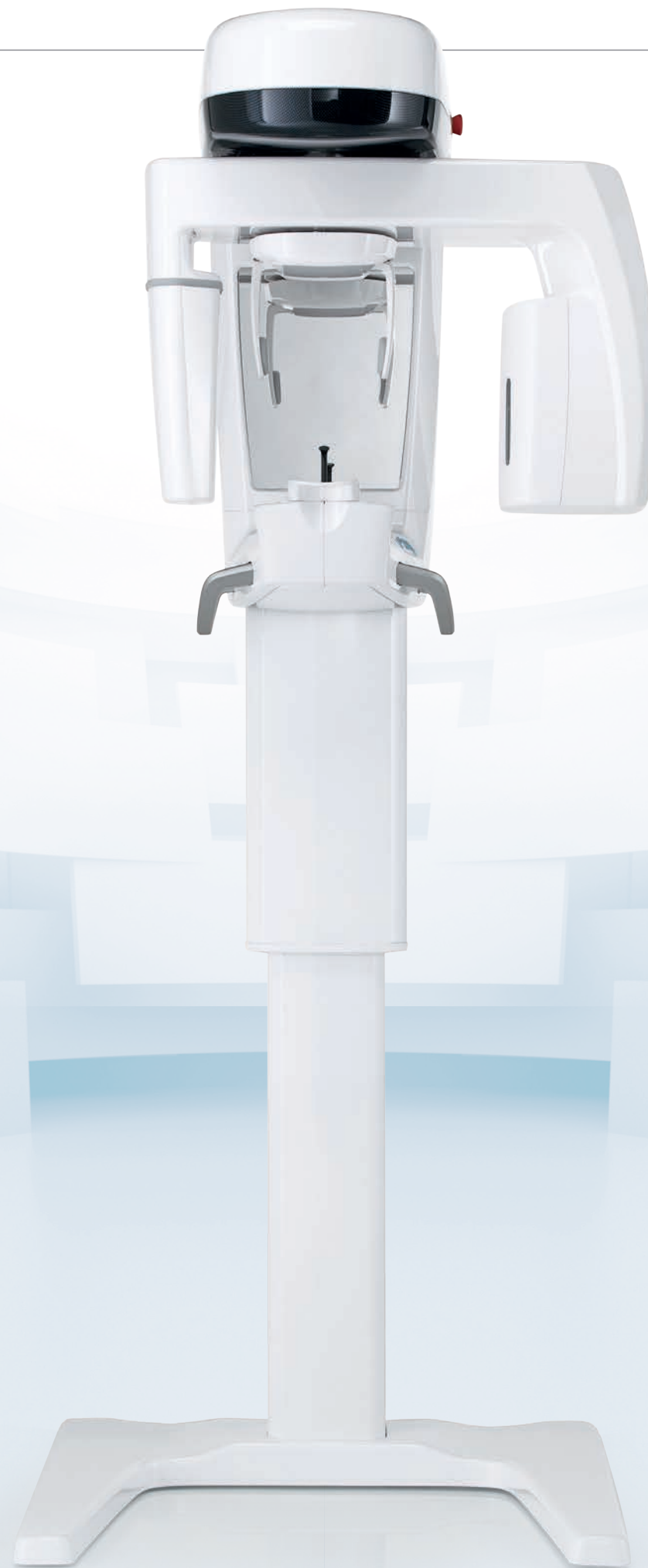

A new 2D outlook

NewTom GO is a new-concept technological device designed for dental practices that require an easy-to-use, innovative, reliable product that guarantees only the very best diagnostic results.



GO: USER-FRIENDLY AND HIGH-PERFORMANCE

EVOLVED 2D

All the potential of 2D, all nicely compact. Offers the advantage of smoother, more efficient dental surgery, thanks to a diagnostic device that is fast, simple, comprehensive and high-performance.

NewTom GO can be installed in just a few simple steps, making it ready for use immediately. Instant display of diagnostic results makes the most of time spent with the patient and allows for improved definition of treatment and future clinical planning.

The stand-by function ensures improved energy efficiency and immediate device reactivation.



A DEPENDABLE RESULT

Absolute image quality - guaranteed by cutting-edge NewTom technology - easy patient positioning and the certainty of the diagnostic outcome allow the dentist to work calmly and time-efficiently.

NewTom GO ergonomics have been designed to maximize functionality and practicality.

PATIENT STABILITY

- Head support unit with four support points: two lateral self-locking cranium supports, chin rest and bite.
- Two solid metal handles for secure patient support.

PERFECT POSITIONING

- Two-speed motor drive for height adjustment of the column.
- Three lasers trace the reference lines for the area of interest.
- Large mirror in front of patient for full view from every angle.
- Servo-assisted control via on-machine keyboard or app for mobile devices.



2D: NEWTOM QUALITY

TECHNOLOGICAL INNOVATION

Latest-generation NewTom technology allows easy diagnosis and effortless post-treatment checks. Outstanding image quality and acquisition speed are essential for creating a fully functional, efficient workflow.

SafeBeam™ technology

The ultra-performance NewTom solution automatically adapts exposure according to the anatomical dimensions of the patient, eliminating any risk of overestimated dosage. Emission parameters no longer need to be set manually. The device can complete scans in just **6.6 seconds**, achieving minimum patient exposure.

Self-adaptive panoramic images

Equipped with a broad, dynamic focal trough, the device automatically adapts exposure parameters to the patient being examined and always provides sharp images. A set of automatic ApT filters helps ensure excellent detail at all times.

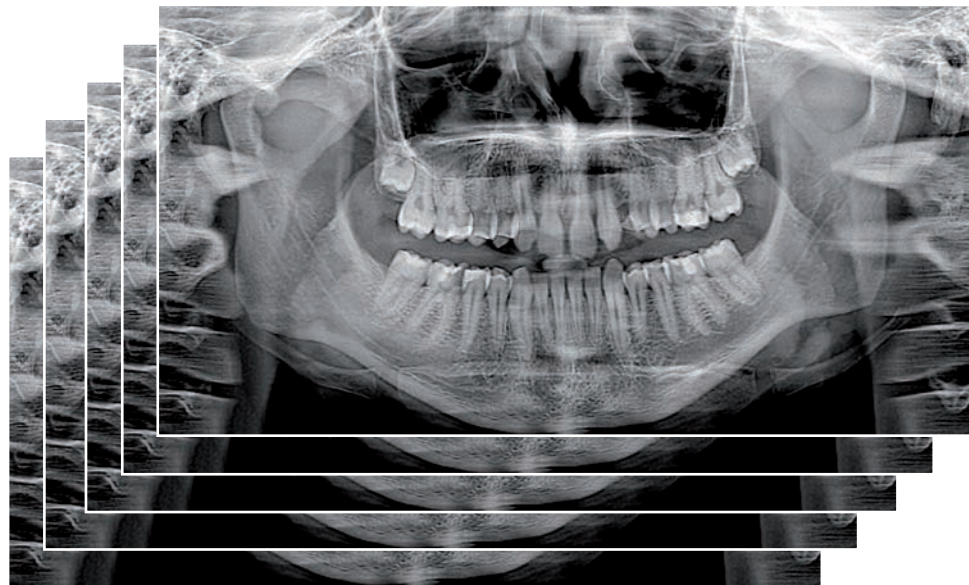

Choice of multiple images

MultiPan can create a set of five different panoramic images with one scan, so the user can choose the most-suitable view. This function is particularly useful when examining complex morphologies.



NNT: INCREASED CONNECTIVITY



Thanks to the Ethernet connection, NewTom GO can be remotely controlled with a user-friendly virtual control panel via a PC or an app that is also available for iPads. This app lets users select the desired scan type and display results in real time, so the examination outcome can be checked immediately. The app also lets users adjust the brightness and contrast of images or enlarge/rotate them.

Images can be modified using the NNT software, which provides precise information on patient anatomy for a variety of clinical applications, smoothing surgery workflows significantly.

Images can be saved in the DICOM 3.0 format, sent using the TWAIN protocol or shared via the viewer incorporated in the software.

Fully integrated 2D and 3D image processing, control and storage – all in a single application.



2D: IN-DEPTH CLINICAL INVESTIGATION

NewTom GO adapts to all the different needs of a surgery by providing a selection of 18 programs.

NNT software automatically applies filters to optimize the images, increasing contrast and enhancing outlines.

Optimal inter-proximal projection and an improved SNR ensure highly detailed dentition images.

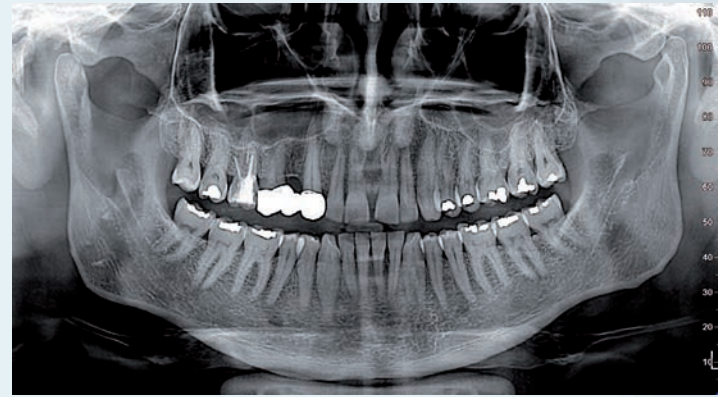
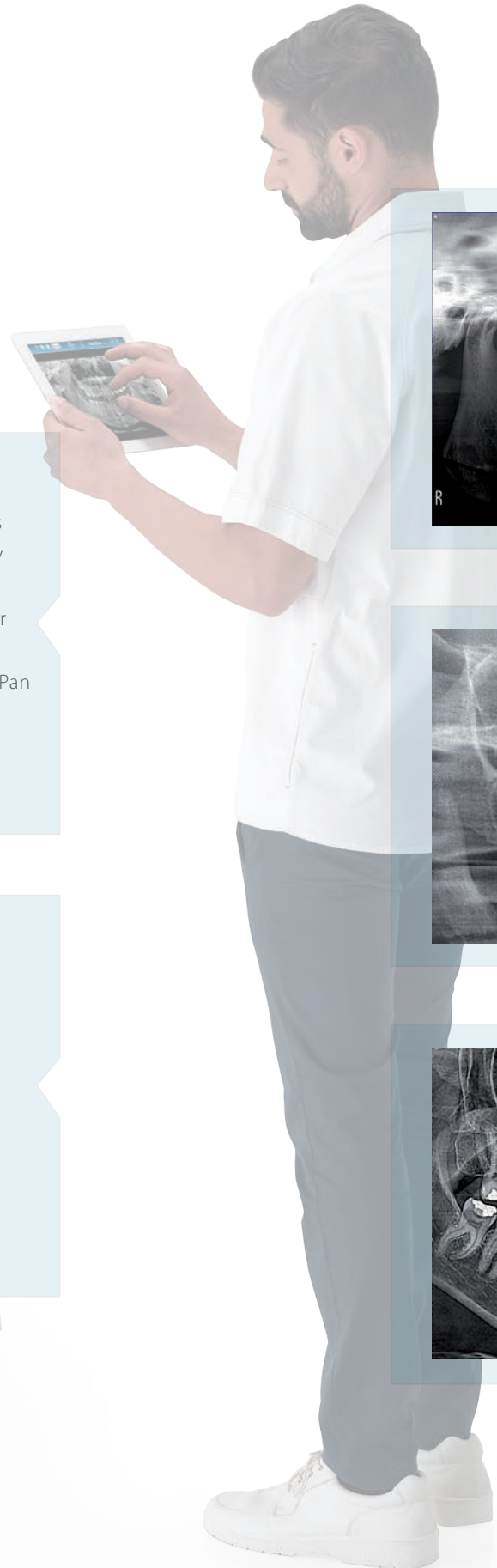

Adult Panoramic

The standard panoramic programs available on the device can display either the entire area or the specific anatomical zone under investigation, reducing scan times and exposure. Moreover, the MultiPan function produces a set of images to choose from.

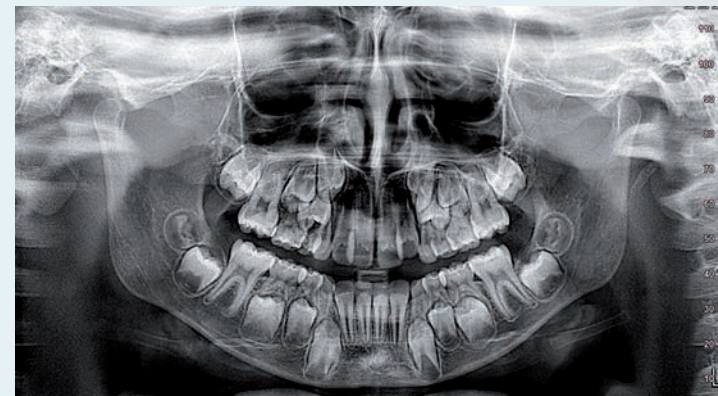

Child Panoramic

NewTom GO also has a specific child protocol to automatically reduce exposure and minimize completion times. The exposed area is smaller, effectively lowering dosage.

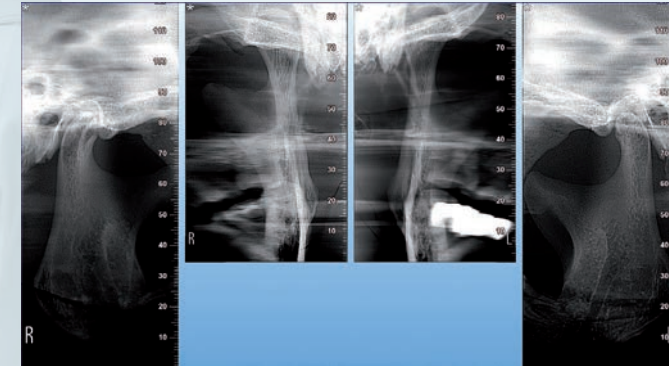

Tempomandibular joint

By selecting the TMJ examination program, four patient projections (two lateral and two postero-anterior) can be obtained in a single scan. The scan can be made with the patient's mouth open or closed.

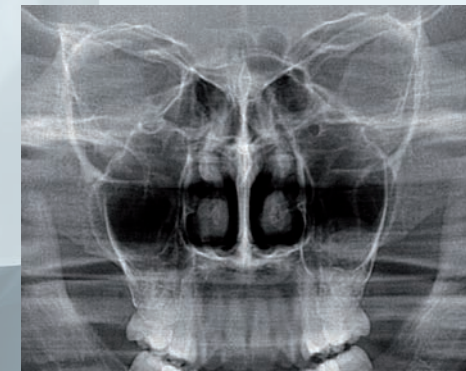

Maxillary sinuses

Where analysis of the maxillary sinuses is required, both AP and LL views can be obtained, both characterized by an image layer expressly conceived to provide sharp, detailed frontal or lateral views.

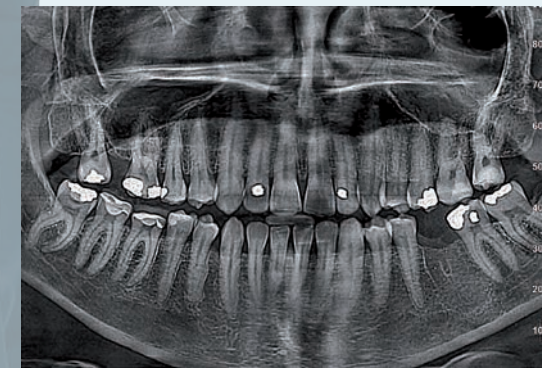

Bitewings dentition

This program provides frontal, lateral, right or left dentition views. Projections feature improved orthogonality to optimize display of inter-proximal dental structures with low exposure.

TECHNICAL SPECIFICATIONS

2D IMAGES

Type	PAN: adult (standard and eco), child, bitewings dentition SIN: Maxillary sinuses PA and LL (right and left) TMJ: Temporomandibular joint (2 x LL +2 x PA) open and closed mouth
Patient alignment	3 laser guides
Sensor technology	CMOS (CSI)
Dimension	PAN standard 15 cm x 28 cm
Image file size	Max 7.5 MB
Image resolution	5 to 7 lpmm
Dynamic range	14 bit (16383 grey levels)
Enlargement	1.25 (± 0.05)
Exposure time	PAN 6.6 - 12 s

X-RAY GENERATOR

Type of generator	Constant potential (DC)
Anode voltage	60 kV – 85 kV (step 1kV)
Anode current	4 mA - 15 mA
Focal spot	0.5 mm (IEC 60336)
Inherent filtration	> 2.5 mm Al eq. (at 85 kV)
Exposure control	Automatic. SafeBeam™ technology

SUPPLY

Voltage Frequency	115 - 240 Vac, ± 10% single phase 50 / 60 Hz ± 2 Hz
Maximum current temporary peak absorption	20A at 115V; 12A at 240V
Current consumption in standby mode	Maximum 0.5 A
Note	Automatic voltage and frequency adaptation

DIMENSIONS

Minimum space required	872 mm (L) x 1025 mm (D) 872 mm (L) x 1101 mm (D) with self-supporting base
Weight	84 kg (185 lb)
Adjustable height	2 speeds motorized
Note	Accessible by patients on wheelchair Self-supporting base available

CONNECTIVITY

Connections	LAN / Ethernet
Software	NewTom NNT
Supported protocols	DICOM 3.0, TWAIN, VDDS
DICOM nodes	IHE certification (Print; Storage Commitment; WorkList MPPS; Query Retrieve)
App	Compatibility with iPad and iPhone

Specifications subject to change without prior notice.

MAIN CONFIGURATION

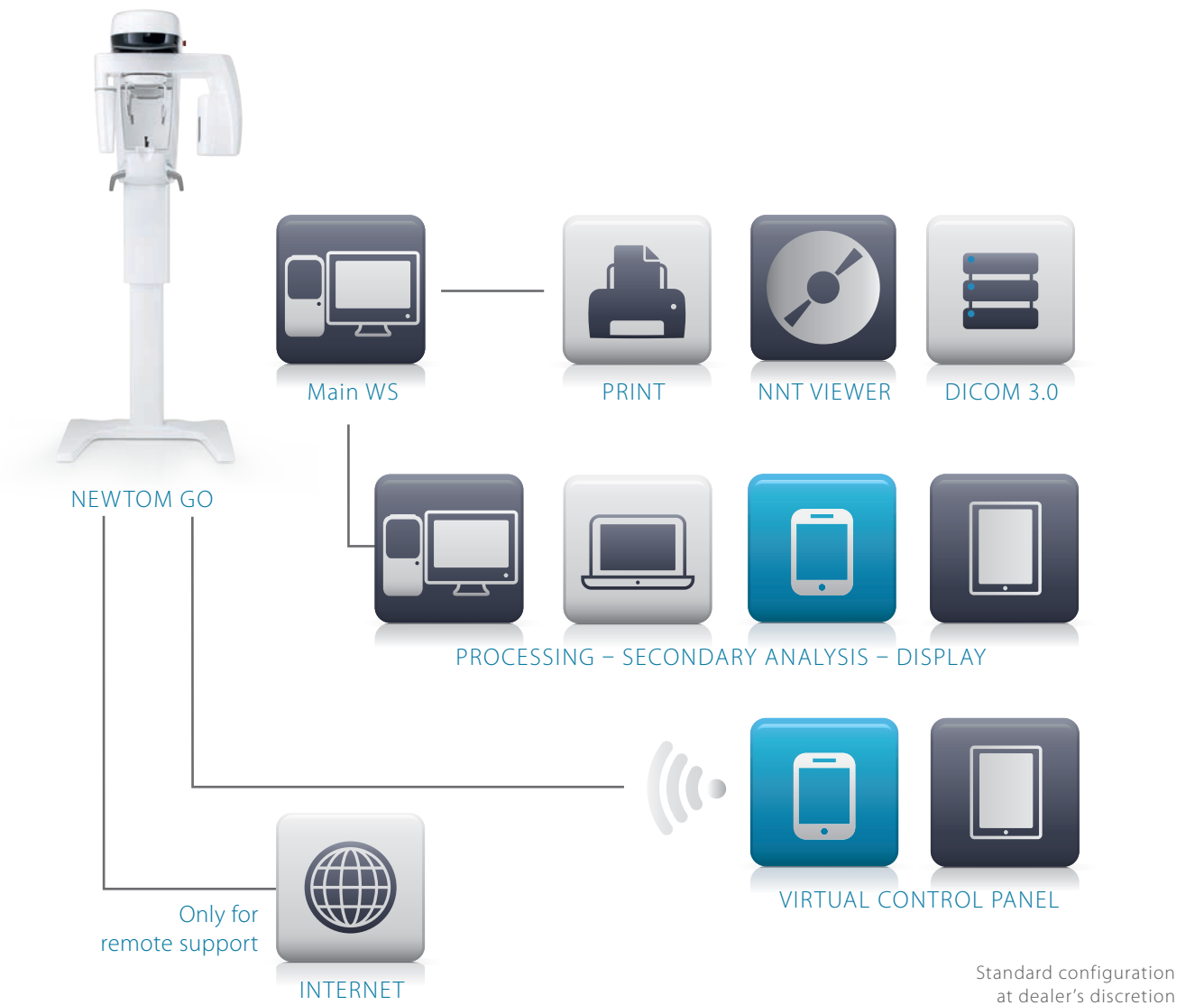

Dimensions in millimeter
(dimensions in inches)

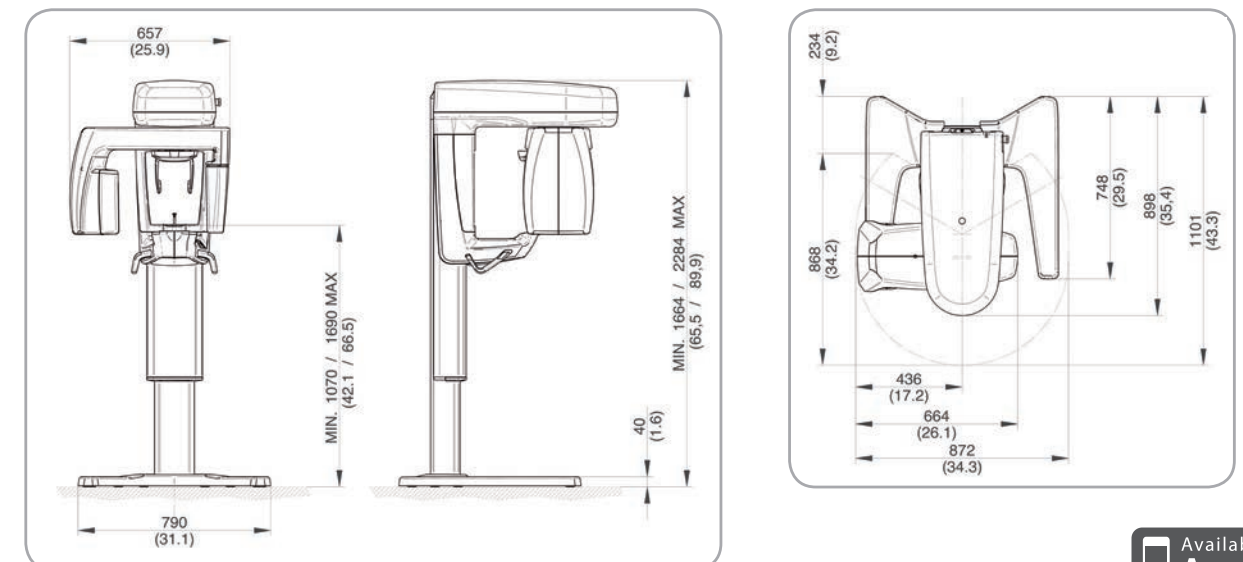

CE
0051

Available on the
App Store